

Features

- Lightweight black anodized aluminum cone
- 4 ohm nominal impedance
- Attractive 6-hole cast frame
- Advanced low distortion motor design
- Solid aluminum phase plug
- Rubber surround

Parameters

Impedance (Ω)	4
Re (Ω)	2.9
Le (mH) @ 1 kHz	0.51
Fs (Hz)	40.4
Qms	2.66
Qes	0.62
Qts	0.50
Mms (g)	14.32
Cms (mm/N)	1.09
Sd (cm ²)	126.7
Vd (cm ³)	76.0
BL (Tm)	4.26
VAS (liters)	24.5
XMAX (mm)	6
VC Diameter (mm)	38
SPL (dB@1W/1m)	88.0
RMS Power Handling (w)	60
Usable Frequency Range (Hz)	40 - 2,200

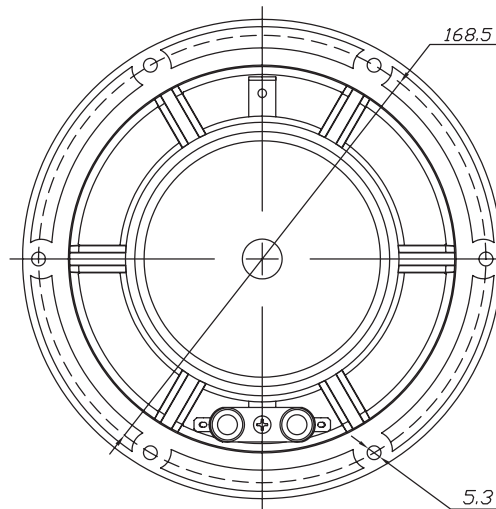
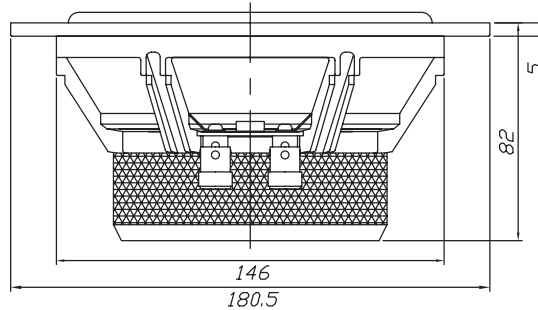

Note: All dimensions in mm.

Frequency Response

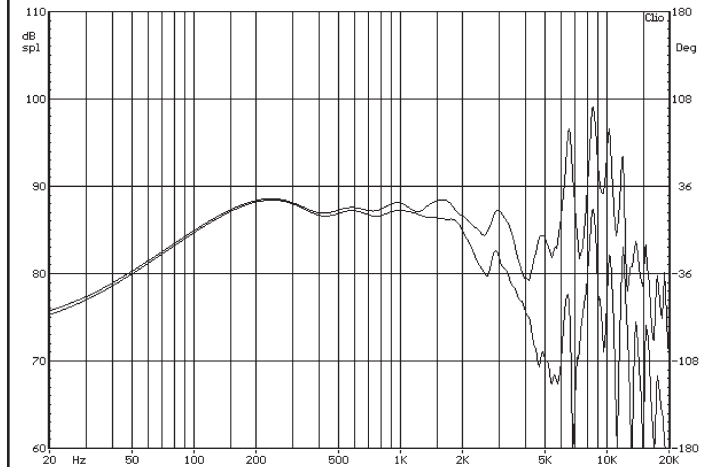

Note: Due to testing limitations, response below 200 Hz is not an actual representation.

Impedance/Phase

