



8-SOURCE 8-ZONE DISTRIBUTED WHOLE HOUSE AUDIO SYSTEM

Model: Matrix88 User Manual



Table of Contents

Safety.....	3
Overview.....	4
Installation.....	13
Before you Start.....	13
Zone / Amplifier Connection	15
Inputs Connection	17
Keypads.....	19
Networking	21
Triggers.....	25
Additional Notes	26
App Control - Matrio™ Control	27
Demo Mode	28
Multiple Device Support.....	29
Zone Control	30
Group Control	31
Device Setup	32
Wireless Audio Streaming	33
Factory Reset.....	35
Standby Control.....	37
Device Specifications.....	38
RS232 Automation and Control	39
Troubleshooting	42

Safety

WARNING! TO REDUCE THE RISK OF FIRE OR ELECTRIC SHOCK, DO NOT EXPOSE THIS APPLIANCE TO RAIN OR MOISTURE.

CAUTION! TO REDUCE THE RISK OF SHOCK, DO NOT REMOVE THE COVER, NO USER SERVICABLE PARTS INSIDE. REFER SERVICE TO A DAYTON AUDIO AUTHORIZED DEALER.

IMPORTANT SAFETY INSTRUCTIONS

- Read and keep these instructions.
- Heed all warnings and follow all instructions contained within this manual.
- Do not use this unit near water.
- Clean only with dry cloth.
- Do not block any ventilation openings. Install in accordance with the manufacturer's instructions.
- Do not install near any heat sources such as radiators, heat registers, stoves, or other apparatus (including amplifiers) that produce heat.
- Do not defeat the safety purpose of the polarized or grounding-type plug. A polarized plug has two blades with one wider than the other. A grounding type plug has two blades and a third grounding prong. The wide blade or the third prong are provided for your safety. If the provided plug does not fit into your outlet, consult an electrician for replacement of the obsolete outlet.
- Protect the power cord from being walked on or pinched particularly at plugs, convenience receptacles, and the point where they exit from the unit.
- Only use attachments/accessories specified by the manufacturer.
- Unplug this unit during lightning storms or when unused for long periods of time.
- Refer all servicing to qualified service personnel. Servicing is required when the unit has been damaged in any way, such as when the power-supply cord or plug is damaged, liquid has been spilled, or objects have fallen into the unit, the unit has been exposed to rain or moisture, does not operate normally, or has been dropped.
- Operate the unit only with the voltage specified on the rear. Fire and/or electric shock may result if a higher voltage is used.
- Do not modify, kink, or cut the power cord. Do not place the power cord in close proximity to heaters and do not place heavy objects on the power cord and/or the unit itself, doing so may result in fire or electrical shock.
- Do not touch the speaker terminals as electric shock may result.
- Ensure that the safety ground terminal is connected to a proper ground. Never connect the ground to a gas pipe, as a severe explosion and/or fire may result.
- Be sure the installation of this product is stable, avoid unlevel surfaces as the product may fall and cause injury, property damage, electrocution and/or fire.
- Note that when the unit is turned off, it is not completely disconnected from the AC power outlet. Do not open the cover.

FCC COMPLIANCE STATEMENT: This device complies with Part 15 of the FCC rules. Operation is subjected to the following two conditions: (1) this device may not cause harmful interference, and (2) this device must accept any interference received, including interference that may cause undesired operation.

Changes or modifications not expressly approved by the party responsible for compliance could void your authority to operate the equipment.

This equipment complies with FCC radiation exposure limits set forth for an uncontrolled environment.

The distance between user and products should be no less than 20cm.

This equipment has been tested and found to comply with the limits for a Class B digital device, pursuant to Part 15 of the FCC Rules. These limits are designed to provide reasonable protection against harmful interference in a residential installation.

This equipment generates, uses and can radiate radio frequency energy and, if not installed and used in accordance with the instructions, may cause harmful interference to radio communications. However, there is no guarantee that interference will not occur in a particular installation. If this equipment does cause harmful interference to radio or television reception, which can be determined by turning the equipment off and on, the user is encouraged to try to correct the interference by one or more of the following measures:

- Reorient or relocate the receiving antenna.
- Increase the separation between the equipment and receiver.
- Connect the equipment into an outlet on a circuit different from that to which the receiver is connected.
- Consult the dealer or an experienced radio/TV technician for help.

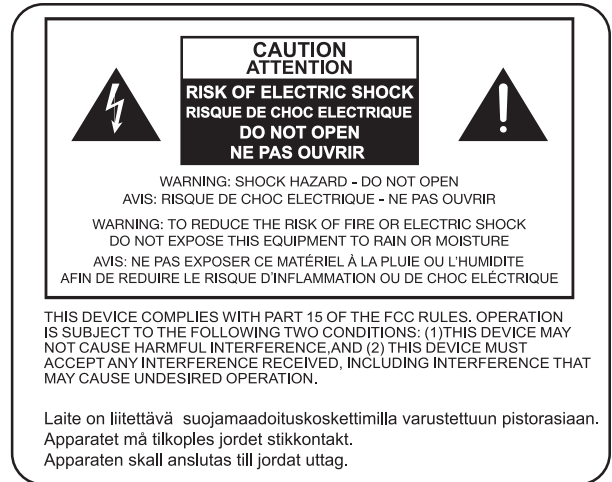

Overview

System Overview

The Matrix88 is an app controlled 8 source, 8 zone audio matrix perfect for creating a custom distributed audio system, or for retrofitting an existing multichannel amplifier to have app control. The Matrix88 offers an extensive list of features for both commercial and residential installations, making it both easy to set up for the installer, and easy to use for the end user. Line level zone outputs offer the flexibility of using the amplifiers or powered speakers that are most appropriate for each zone, even allowing usage of existing equipment. A variety of audio inputs and wireless audio streaming support make listening to your favorite music or audio programs a breeze. The Matrio Control app offers total control over the system, and also allows full customization of zone and input names for simple usage by the end user after setup.

The Matrix88 Kit includes the following components:

- 1 x Matrix88 Master Controller/Amplifier
- 1 x Rack Mounting Kit
- 1 x Ethernet Cable
- 1 x RS232 (serial) to USB Cable
- 1 x Quick Start Guide

The following optional accessories are available and can be purchased separately.

- **DAX88KP** – Wall Mountable Keypads that will allow control of all basic functions for each zone, such as volume, source selection, and bass/treble adjustment
- **DAX88IR** – IR Remote Control for operating Matrix88 Keypad functions

Overview – App Control

Dayton Audio Matrio Control Mobile App

The Dayton Audio Matrio Control app allows for complete control of all of the Matrix88 or DAX88 units on your network. The Zone Control menu allows for individual control over each zone of your system, and the Group Control menu is an advanced feature that lets you send commands to many or all zones at once, even zones that are on separate units. The settings menu has controls for custom naming your inputs, zones, and even the device name. All customization is stored on the Matrix88 or DAX88 itself, which means that end users can open the app can use the system without any knowledge about how the system is wired.

For more detailed information about Matrio Control, see the dedicated Matrio Control section of this guide (p.27) and also download the free app from the iOS or Android app store. The app can be fully explored and experienced in demo mode even without a Matrix88 unit.

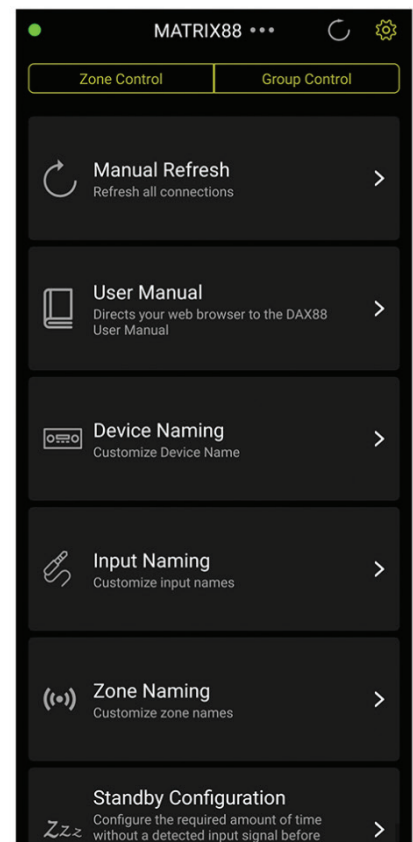
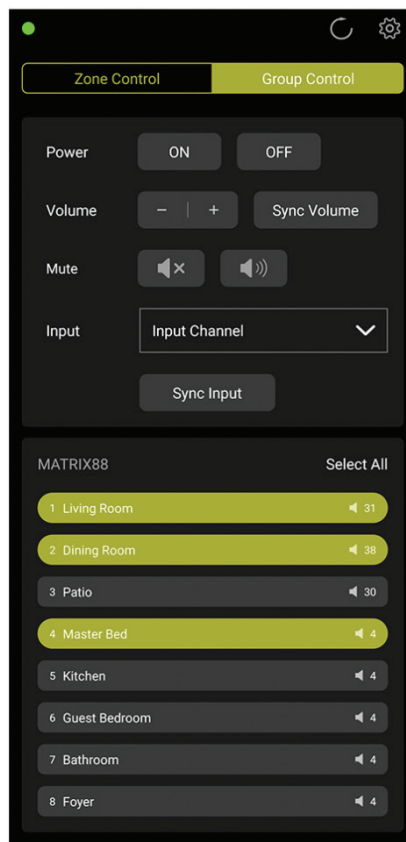
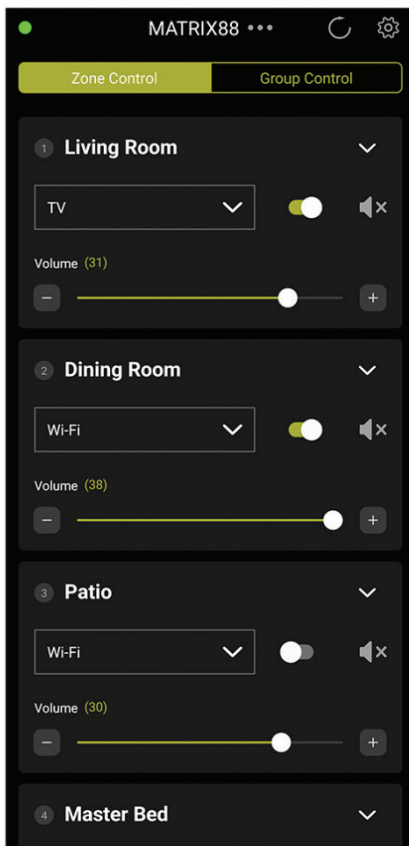
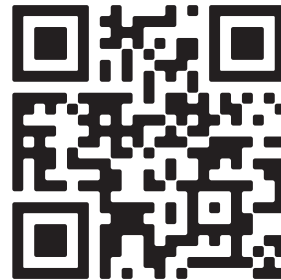

Overview – Front Panel

Matrix88 Front Panel

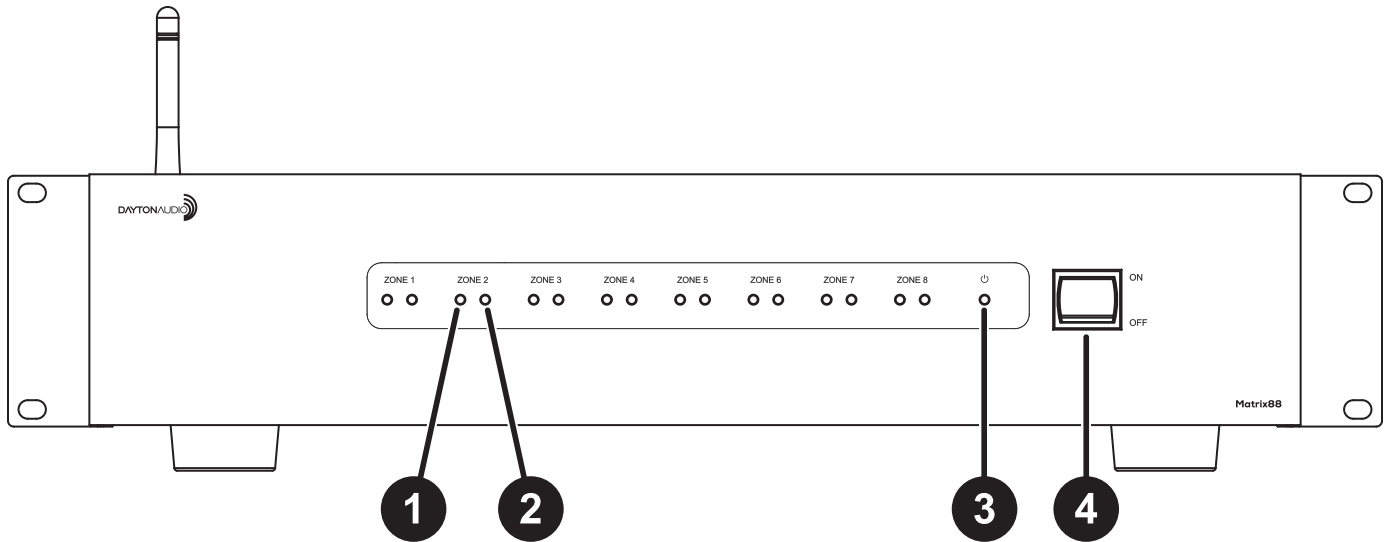

1. **Zone Signal LED** – If the input that is assigned to the corresponding zone has audio playing, the LED will be BLUE. The LED will be OFF if the input is not currently playing audio, or the wrong input is selected for the Zone.
2. **Zone Status LED** – Displays RED if the device's power is on, but the corresponding zone is OFF. This LED displays BLUE if the zone is enabled. Zones can be turned on and off via the Matrio Control app, keypads, inputs triggers or RS232 Control.
3. **Power LED** – Indicates the power status of the Matrix88. The LED displays RED if the DAX88 is connected to power and the device is switched on, otherwise the LED is off.
4. **Power On/Off** – Toggles the DAX88 ON and OFF.

Overview – Rear Panel

Matrix88 Rear Panel

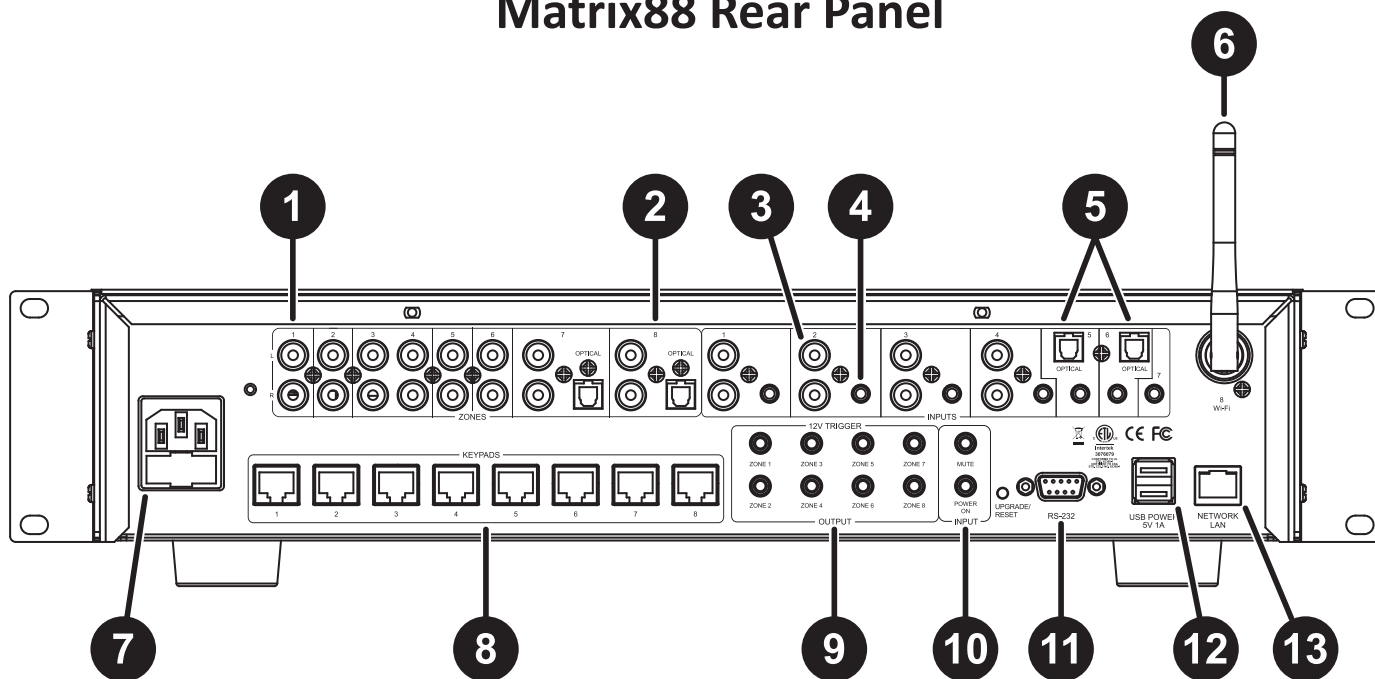

- 1. Zone Preamp Outputs 1-6** – Zones 1 through 6 on the Matrix88 are preamplified, analog line level audio zones in the form of stereo RCA jacks. These outputs can be connected to external amplifiers.
- 2. Zone Preamp Outputs 7-8** – Like the previous Zones, Zones 7 and 8 have preamplified, analog line level RCA connections for connecting external amplifiers. These zones also have Optical Toslink outputs for connecting external equipment with a digital Toslink connection.
- 3. Stereo RCA Inputs** – Inputs 1-4 have stereo RCA jacks for connecting any analog input source like TV's, DVD players, Streamers, CD players, etc.
- 4. Stereo 3.5mm Inputs** – Every input 1-7 has a stereo 3.5mm jack for connecting analog input sources such as cell phones, tablets, laptops, wireless receivers, etc.
- 5. Optical Toslink Inputs** – Inputs 5 and 6 feature optical Toslink inputs, which are useful for attaching digital audio sources, such as from a TV, DVD player or wireless streamer. The output of your audio source must be manually set to Stereo PCM if automatic settings do not work.
- 6. Wi-Fi Antenna** – Allows the Matrix88 to be connected to your network wirelessly. Dayton Audio recommends to always use a wired ethernet connection instead of Wi-Fi whenever possible.

Overview – Rear Panel

7. **AC Input** – This unit comes with an IEC jack that permits the removal of the AC power cord. This allows flexibility of changing the power cord for different countries. The IEC socket also houses the main fuse holder. Plug the power cord supplied with the amplifier into this socket and to a wall socket or appropriate surge protector.
8. **Keypad Connections** – These RJ45 jacks allow you to connect optional DAX88KP Keypads, which allow per zone control without the use of the mobile app. Note: These ports are labeled 1-8, however the dipswitches on the back of the keypad need to be configured so they control the correct zone (p.19).
9. **12VDC Trigger Outputs** – Useful for automation systems, each zone has a corresponding 12V trigger that will output 12V when the zone is on, and 0V when the zone is off. This can be useful to trigger the power state of other equipment like external amplifiers, video screens, or anything else with a 12V input trigger that corresponds with that zone (p.25).
10. **12VDC Trigger Inputs** – Applying 12V to the Mute Trigger will mute all zones, and will unmute all zones if the signal is removed (0V). Applying 12V to the Power On Trigger will turn on all zones. The Zones will remain on even when the 12V signal is removed. The power on trigger can be even more useful when combined with the automatic standby function (p.25).
11. **Serial Port for RS232 Control and Device Updates** – This port allows RS232 commands to be sent to and from the DAX88, which can be useful for automation systems. This port can also be used to upgrade the firmware on the Matrix88. See the “RS232 Control” section for more details.
12. **USB Power Outputs** – Useful for powering or charging external devices such as streamers, tablets, etc, these USB ports are for power only and will not transmit any data. The ports are capable of 5V, 1A of output each.
13. **Network LAN Connection** – This RJ45 jack allows the DAX88 to be connected to your network via a standard ethernet patch cable.

Overview – Keypads

DAX88KP – Keypads (Optional)

The DAX88KP Keypad is designed for ease of use with accessible controls over the corresponding Matrix88 zone. Soft-touch backlit buttons and a backlit LED display provide convenient control of the zone's power status (ON/OFF), source selection, volume, treble, and bass controls. A built-in IR target or external IR target connected to the EXT-IR terminals on the rear of the keypad, relay commands to the Matrix88 main unit through your DAX88IR IR Remote. A DAX88KP will control one zone at a time, which is configurable with dip switches on the back of the keypad.

Five LEDs on the keypad face indicate the operational function of the keypad. The EXT LED indicates that the system is receiving a trigger command from an external IR target.

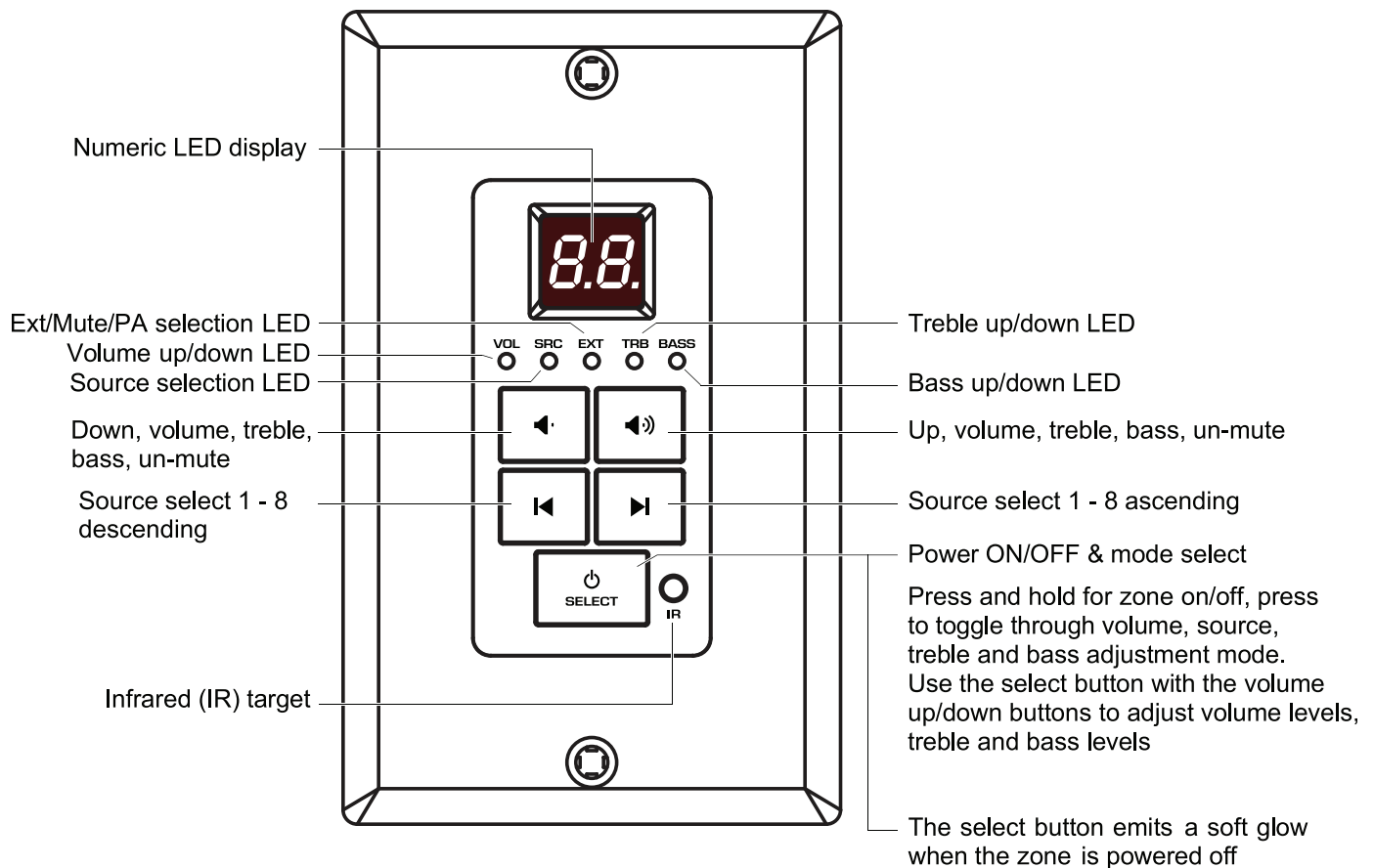

Overview – IR Remote

DAX88IR – IR Remote for Keypads (Optional)

The DAX88IR Infrared Remote Control provides complete zone control through the built-in IR receiver on the Matrix88's keypads. All keypad functions can be accessed using the DAX88IR. In addition to the keypad functions, the DAX88IR has a mute button to temporarily mute audio in the corresponding zone. Once the mute function is activated the keypad's LED display will flash, indicating the mute status is active. To deactivate mute, press the mute button again on the DAX88IR Remote, or disable mute with the Matrio mobile app.

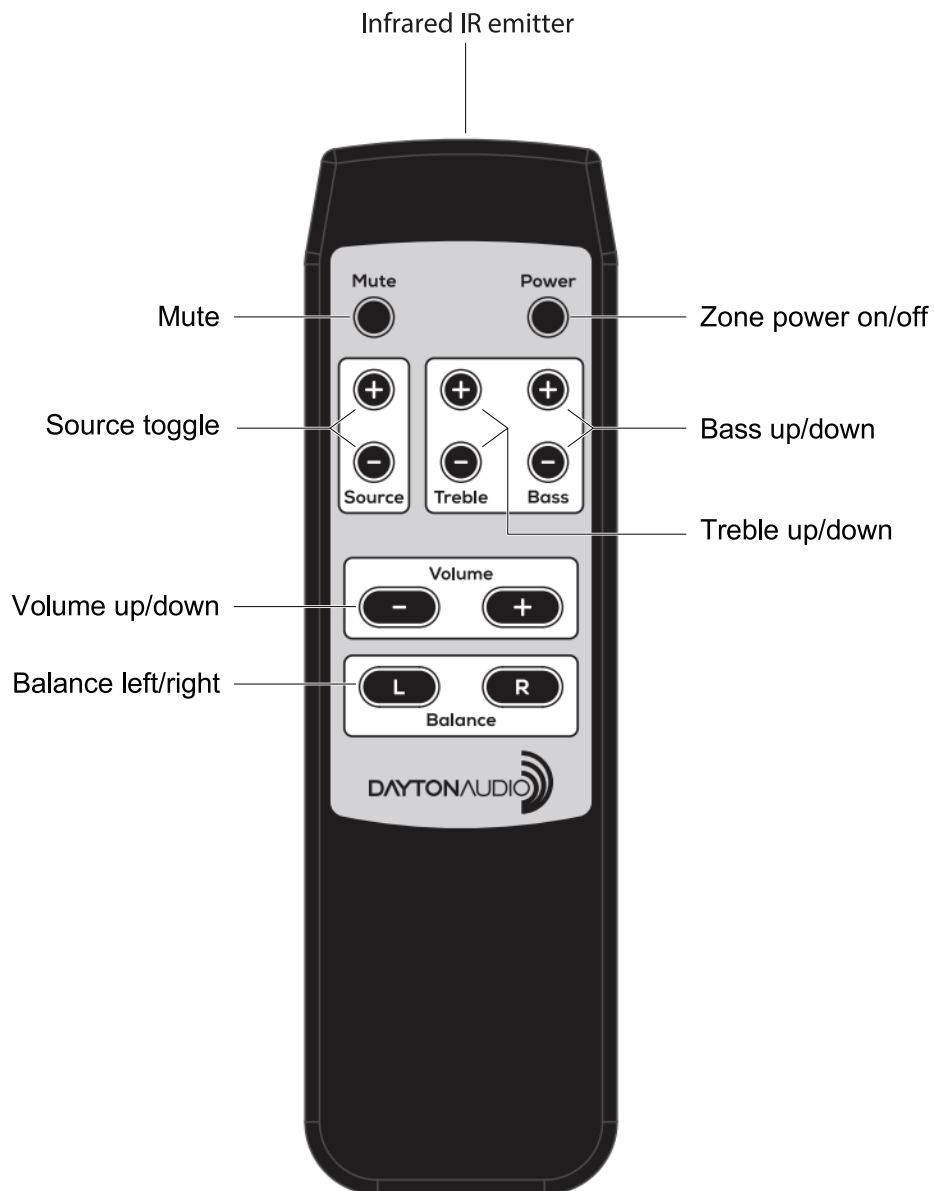

Overview – External Devices

Amplifiers, Streamers and other External Devices

Zone Outputs

As a line level device meant for distributing audio, the Matrix88 will require external equipment in order to produce sound. Specifically, it will require external amplifiers to power your speakers. The Matrix88 cannot drive speakers directly unless the speaker has a built-in amplifier. The Matrix88 is compatible with any amplifier that has an analog, unbalanced line input, or an optical input accepting stereo PCM. The connector type used on the Matrix88 for output are stereo RCA jacks. However, common adapters can be found at any audio retailer to adapt these outputs to work with 1/8 inch (3.5mm) or 1/4 inch cables.

Examples of common output devices for the Matrix88 are:

- 1) A multi-channel amplifier that does not have app control** – The Zone Outputs of the Matrix88 can be used as a source for each of the zones on any multichannel amplifier, (p.16) which can be used to bring smart features to an existing amplifier, effectively upgrading your multichannel amplifier to function similarly to a Dayton Audio DAX88.
- 2) A 70V Amplifier** – Many commercial installations already use amplifiers like this to power many speakers in a row that all play at once and do not require individual control. The Matrix88 can be used as the audio input to an amplifier like this, which can bring app control to an existing installation. This might be especially useful if you intend on expanding a business with existing audio that already works, but you want to add more zones with individual control.
- 3) Powered Speakers** – With speakers that already have amplification built in, such as studio monitors, party speakers, PA Speakers, etc, the Matrix88 can be easily connected to these speakers analog inputs and used in a larger whole home or business system.
- 4) Powered Subwoofers** – The Matrix88 can be easily connected to most powered subwoofers, as long as they have analog inputs. In the example above of upgrading an existing 70V Amplifier system, you could use one zone to connect to the 70V amplifier, and another to a powered subwoofer or subwoofer amp to add some oomph to the environment the 70V system is in.
- 5) Amplifier Flexibility** – In one room, you might only require 50W per channel to power your ceiling speakers. In another room, you might have a 500W amplifier powering some big tower speakers. Unlike multichannel amplifiers, the Matrix88 gives you the flexibility to put the power where you need it, while maintaining control over each zone with the Matrio Control app.

Overview – External Devices

Input Devices

The Matrix88 has RCA inputs, 3.5mm inputs, and even digital optical inputs to make it a breeze to attach any input device you might have to your Matrix88, such as an external streamer, TV, radio, CD player, turntable or anything else you can think of. The included USB power jacks provide 5V, 1A of power which is enough to power many external streaming devices, such as Airplay receivers, Chromecasts, Alexa Devices and more.

Triggers

The included input and output triggers can be useful for additional automation of your system. For example, your external amplifier, might have input triggers that can turn the device on when it sees a 12V signal. The Matrix88 can output a 12V signal from any zone when it is turned on, which could turn on your external amplifier. Or, perhaps you have a projector screen that you want to come down from the ceiling when zone 4 turns on. If the motor of the screen has a 12V input, this can be easily done. For more information, see the section on Triggers (p.25).

Installation – Before you Start

Matrix88 Installation

With included feet and rack mount options, the Matrix88 is easy to install in a variety of scenarios. Install the Matrix88 in a well-ventilated location. Make sure that your installation of the Matrix88 does not impede airflow to your connected amplifiers or networking equipment. The Matrix88 should not be placed directly on top of an amplifier or other heat generating equipment, especially if it blocks any vents. Do not expose the unit to excessive dust, do not allow dust to build up on the unit.

Overview (Read Fully Before Installation)

1. The Matrix88 can be mounted in a standard 19" A/V equipment rack using the included rack mount kit.
2. When possible, test that all of your speakers, amplifiers and input devices are working properly before attaching them to your Matrix88.
3. Plan on installing your Matrix88 in a location where you will have wired network access. This means you can install the Matrix88 near a network switch, or plan to run a Cat6 network wire from your router to the network port of your Matrix88. Although it is possible to configure the Matrix88 to the network using Wi-Fi, it is not recommended for stability. More details about network configuration are found in the sections below. If you connect your Matrix88 wirelessly, it is imperative to have a strong signal.
 - a. Ensure that you have a robust and stable wireless network before installing your Matrix88, even if you are connecting your Matrix88 to your network via ethernet, as interfacing with the device will still happen wirelessly via a phone, tablet, etc. Control of the Matrix88 through the Matrio Control app will not work properly without a working and reliable wireless network. If connecting your Matrix88 wirelessly, your network must support the 2.4Ghz spectrum.
 - b. If you are using a router that was given to you by your internet service provider, consider upgrading to a higher quality router, as ISP provided routers are often not of high quality, especially units that are both modem and router combined.
 - c. Plan to have a secure wireless network with access to the same VLAN that the Matrix88 is connected to, that only trusted phones, tablets, etc will have access to. With the Matrio Control app, any user on the same network as the Matrix88 will be able to make changes to the system via Matrio Control.
4. Use high quality cable for connection of the keypads to the Matrix88. We recommend Cat5e cabling to connect keypads, but you can also use Cat6 or better. Because audio is not transmitted through this cable, the performance of Cat5e at a minimum is adequate. Higher quality ethernet cable will NOT improve audio performance. Buying cabling pre-terminated with RJ45 connectors (ethernet patch cables) might be desirable if you do not want to terminate the wire yourself. Additionally, keypads must be configured using the dipswitches on the back of each keypad. Plugging a keypad into the first keypad port will not make it control zone 1 automatically, you must configure the dip switches.

Installation – Before you Start

5. Following installation of your Matrix88 unit, amplifiers, speakers, inputs, keypads and other accessories, the power switch on the front of your Matrix88 device will need to be switched to the 'ON' position before it can be used.
6. It is highly recommended to label all of your wires during the installation process, which will make it much easier to fully setup your device in the Matrio Control app following installation.
7. The Matrix88 provides convenient 5W USB-A ports (5V, 1A) to power additional streamers, adapters, tablets, or any other USB powered devices. These USB ports are not an audio input, and will not interface with the Matrix88. These ports will each provide 5W even if both are being used at once.
8. Use high quality amplifiers with the Matrix88. Test all amplifiers before connecting them to your Matrix88.
9. When first turned on, each of the Matrix88's zones will be off, and will need turned on for use. The default matrix routing is that input 1 is routed to zone 1, input 2 is routed to zone 2, and so on. Keep this in mind when you first test your Matrix88 after installation.

Installation – Zone / Amplifier Connection

Zone Connection (Connecting External Amplifiers)

The Matrix88 is a line level device, with 8 stereo zones represented with RCA jacks on the back of the unit that will output line level analog audio signals. RCA outputs can be used to distribute an audio signal to amplifiers, powered speakers, or even a powered subwoofer. Connect one end of a set of RCA cables to your desired zone of the Matrix88, and connect the other end to your amplifier or speaker.

A Note on Cables: Use only high-quality, single ended, shielded RCA cables for connecting external amplifiers to the Matrix88. It is not necessary to use esoteric materials or audiophile branded cables for your system. However, there are many RCA cables (often included with devices, rather than individually sold) that are very low quality and can introduce noise into your system. If you are unsure where a set of RCA cables came from, it is fair to try them with your system. But if there are any unexpected issues with sound quality, such as audible noise or distortion, we recommend trying higher quality cables from a reputable company first. Many cables do not have any shielding, use poor quality materials, have poor construction, etc. If the audio quality of your system is good but you want it to be better, we recommend upgrading your speakers or amplifiers, not your cables unless there is a distinct issue with your cables.

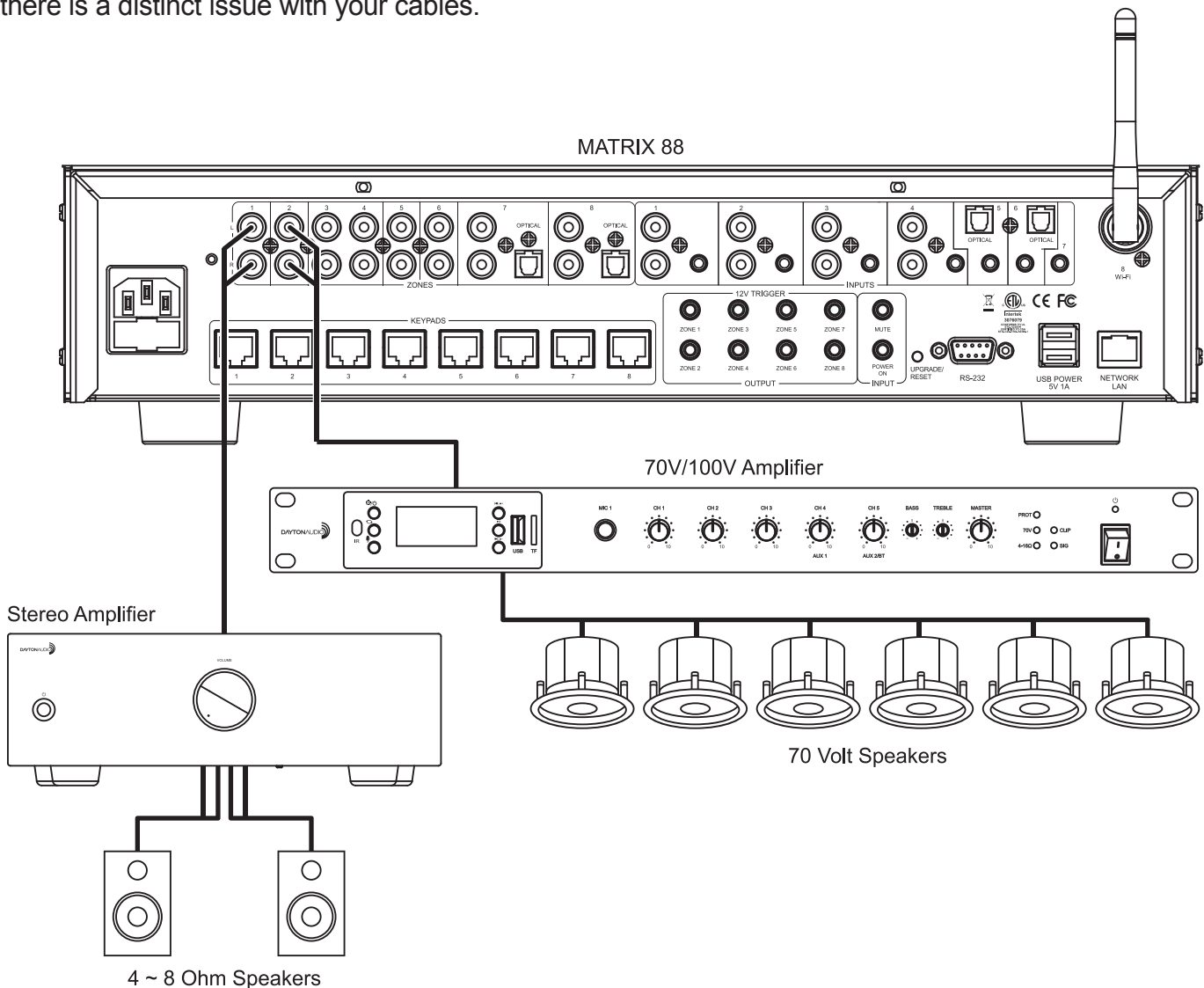

Installation – Zone / Amplifier Connection

Example - Connecting to a Multichannel Amplifier

A typical use case of the Matrix88 is to connect it to an existing multichannel amplifier to retrofit the device with app controllable features and wireless streaming. These amplifiers often have inputs for each zone of amplification, so each zone output of the Matrix88 can be connected to the zone input of the multi-channel amplifier, and effectively add the network controllable features of the Matrix88 to the amplifier. In this scenario, it is often helpful to connect the output triggers of the Matrix88 to the input trigger of your amplifier, as seen in the trigger section.

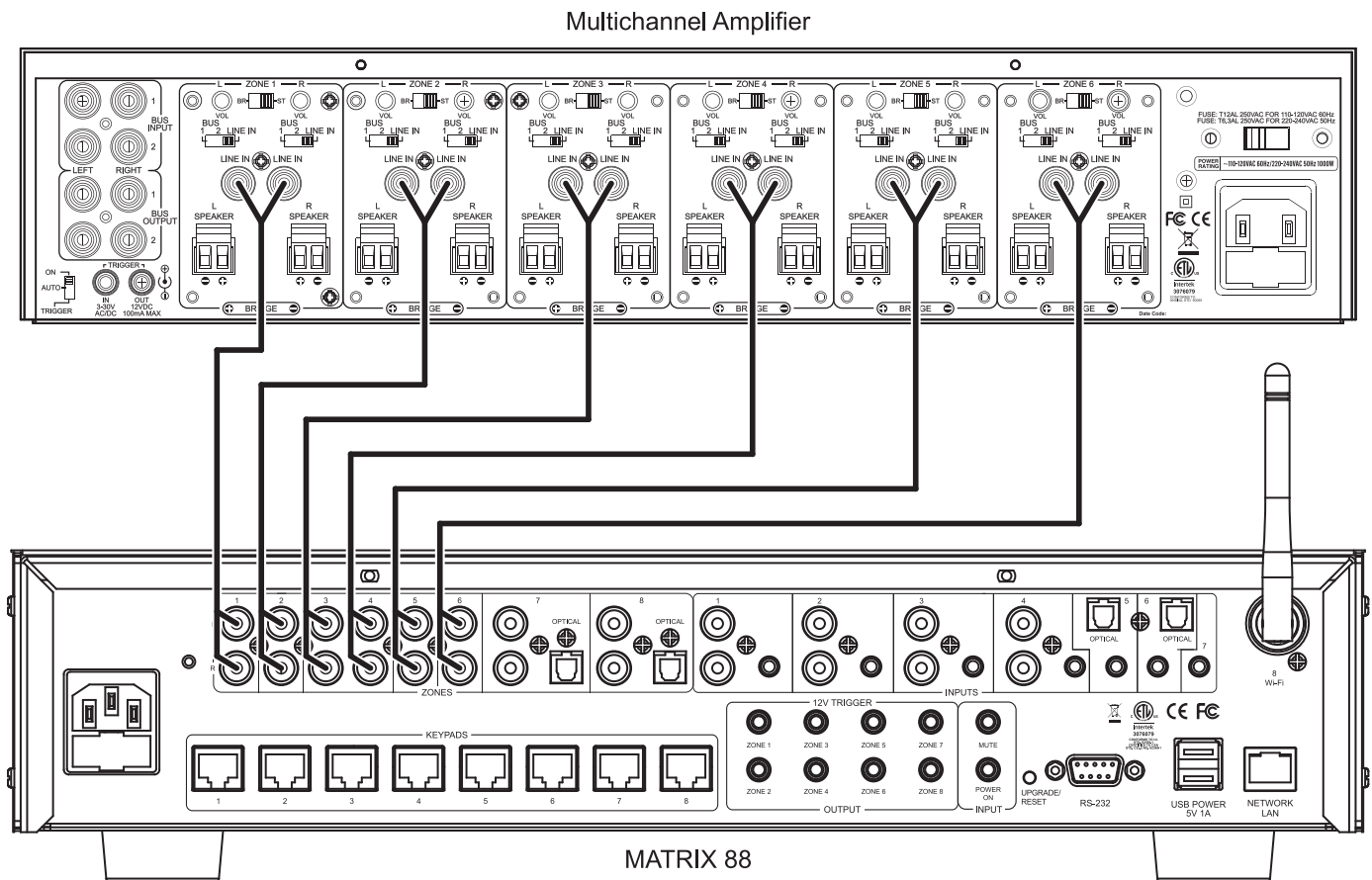

Installation – Inputs Connection

Input Connection

The Matrix88 has 8 inputs with a variety of connector types (RCA, 3.5mm, Digital Optical, and wireless streaming). These inputs are part of the device’s matrix, which means any input can be assigned to any zone and changed at any time. For example, one day you might want a different input per each zone for individual listening. The next day, you might want to broadcast your TV audio to every zone so no one misses anything about the big game. With the Matrio Control app, each input can be given a custom name that better describes it and makes it simple for the end user to control. Use only high quality cables for connecting external inputs to the Matrix88.

- **Inputs 1 – 4** are stereo, unbalanced, line level source inputs via RCA style female connectors or a female 3.5mm jack. If both inputs are present, the audio from each will mix together.
- **Inputs 5 – 6** have options for TOSLINK (optical) input, or analog audio input through a 3.5mm jack.
 - If using TOSLINK, make sure to use “PCM-Stereo” or Auto Detect setting on your source device. Your device should be set to auto detect by default and work properly, but if not, you can usually find these settings in settings -> Audio -> S/PDIF or something similar. Refer to the user manual of your source device. You will know if your settings are correct or not, because if they are incorrect, the sound will be digital noise rather than proper audio. Keep the volume of any zones set to this input very low until you have verified the audio is correct and not digital noise.
 - The 3.5mm jack will take priority over the TOSLINK input, meaning that if anything is plugged into the 3.5mm jack, the TOSLINK input will be disabled. These inputs will NOT mix.
- **Input 7** is a 3.5mm jack for analog, stereo audio.
- **Input 8** is Wi-Fi streaming, and is represented on the back of the Matrix88 with a wireless antenna. More information about wireless streaming can be found in the “Wi-Fi Streaming” section of this guide (p.32).

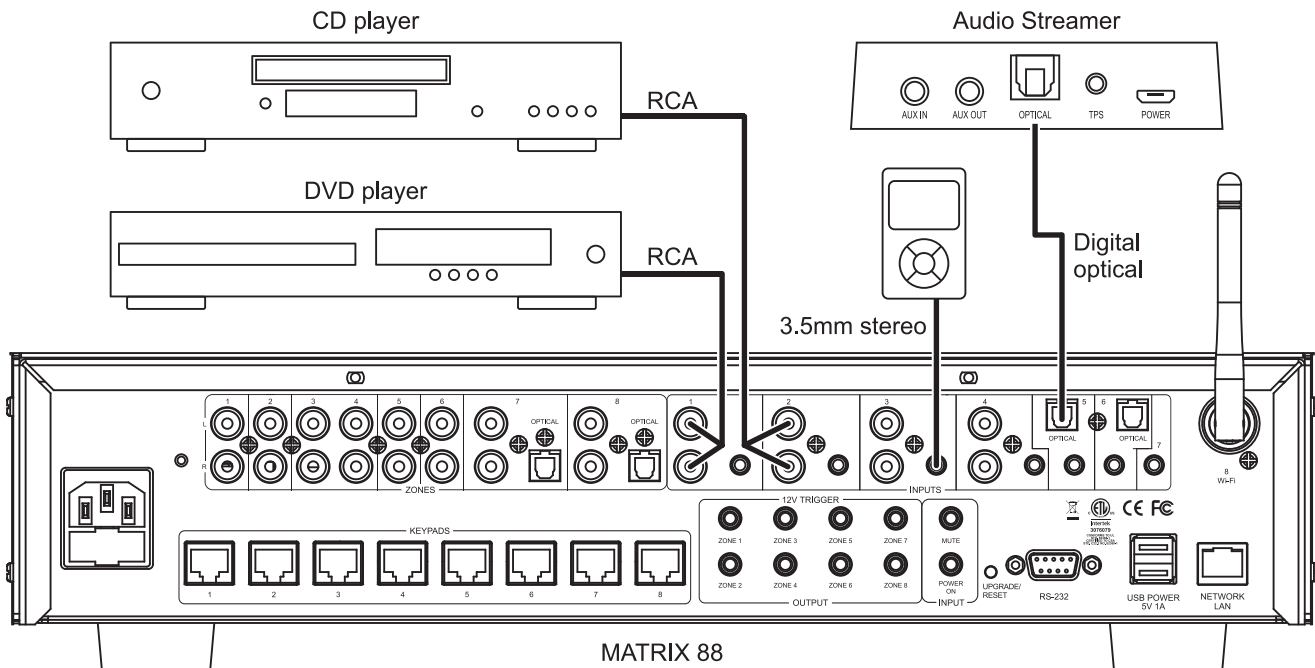

MATRIX 88

Installation – Inputs Connection

Sharing your Inputs to Multiple Matrix88 Units

If you have multiple Matrix88 units and want to use the same input device on all of them, you have a couple of options.

1) The preferred option is to split your input source and route it to both devices. There are many devices and cables available from your Dayton Audio retailer that will split an analog or TOSLINK signal so you can connect it to multiple Matrix88 devices. You will need to name both inputs the exact same name within the Matrio Control app for each Matrix88 unit to ensure that group control input switching works correctly. See the diagram below, which is an example using a CD player as an input connected to Matrix88_1 and Matrix88_2 using an aux splitter (male 3.5mm to dual female 3.5mm).

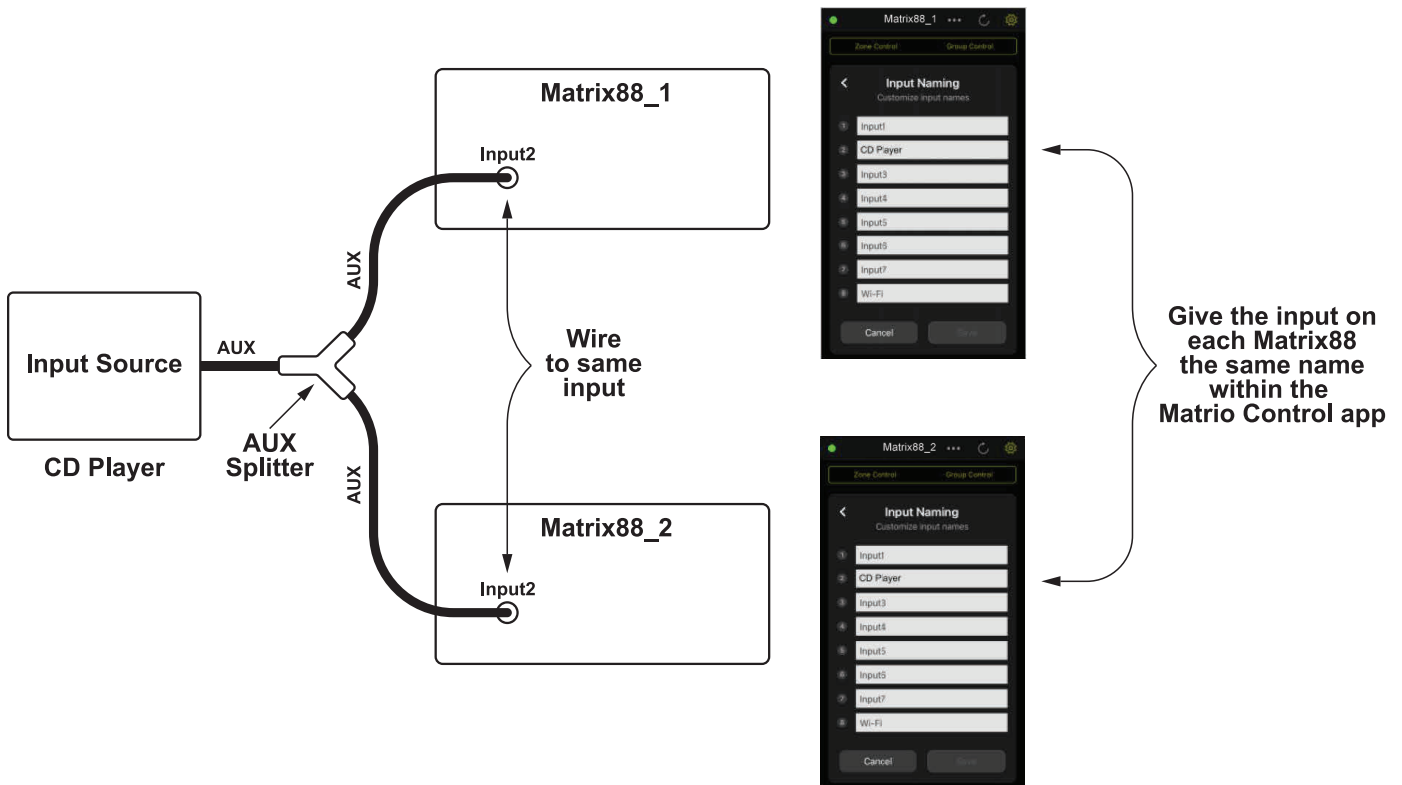

2) All of the Matrix88's zones are line level RCA outputs. One of these zones could be used to route the desired audio source from your first Matrix88 into your second Matrix88. For example, if you are streaming music using the Wi-Fi input of your first Matrix88, set either zone 7 or 8 of your first Matrix88 to input 8 (Wi-Fi), and then connect zone 7 or 8 to one of the inputs on your second Matrix88. This will effectively share the desired input between your devices if the correct zone on your main Matrix88 is turned on.

Installation – Keypads

Keypads

In addition to control via the Matrio Control app, each individual Matrix88 zone can be controlled with keypads that can be mounted into a standard single-gang wall plate. Up to 8 keypads (one per zone) can be installed directly to the Matrix88 via the 8 RJ45 jacks (also known as an ethernet jack). Keypads offer convenient control for volume, source input, bass and treble. The keypads also feature an IR sensor that can be used with the DAX88IR Remote Control to control a keypad wirelessly.

- 1) Use high quality Cat5e/6 cable between the Matrix88 and DAX88KP keypads. Proper installation techniques will guarantee that the keypads will work properly up to 600 feet from the Matrix88. The use of RJ45 (typical ethernet) connectors on the keypads and keypad hub means that pre-terminated cables can be easily sourced, and the equipment to terminate Cat5e/6 cable yourself can be easily found, if necessary.
- 2) Use standard electrical boxes or low voltage rings to mount the keypads.
- 3) **The switches on the back of the keypad must be configured so they control the correct zone.** Although the Matrix88's keypad jacks are labeled with 1 – 8 for each of the eight zones, the dip switches on the back of the keypads must be set so they correspond to the correct zone like the chart below shows. Plugging the keypads into the 1 – 8 labels of the hub does NOT determine which zone each keypad controls. Setting the dip switches gives each keypad a distinct address. The up position is 'ON', whereas the down position is 'OFF' This chart is also found on each keypad for ease of installation. The example on the right has the correct settings for "Zone 3". **IMPORTANT:** If you do not complete this step for each keypad, your keypads will not control the correct zone.

Zone	1	2	3
Zone 1	ON	ON	OFF
Zone 2	ON	OFF	ON
Zone 3	ON	OFF	OFF
Zone 4	OFF	ON	ON
Zone 5	OFF	ON	OFF
Zone 6	OFF	OFF	ON
Zone 7	OFF	OFF	OFF
Zone 8	ON	ON	ON

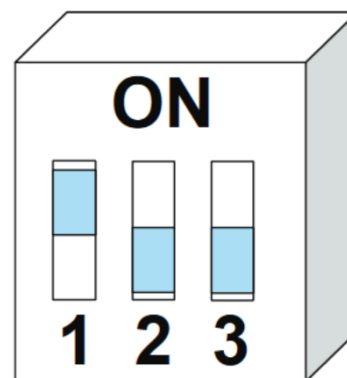

Installation – Keypads

- 4) If you are crimping your own RJ45 jacks, the 'B' configuration should be used. This is the 'standard' configuration, and is how a typical ethernet patch cable you would buy from a retailer is wired.
- 5) A standard IR target can be attached to the back of the keypad to the green port with labels +5V, GND, and Data. This can be useful if you want to be able to point the remote a different direction than where the keypad is.

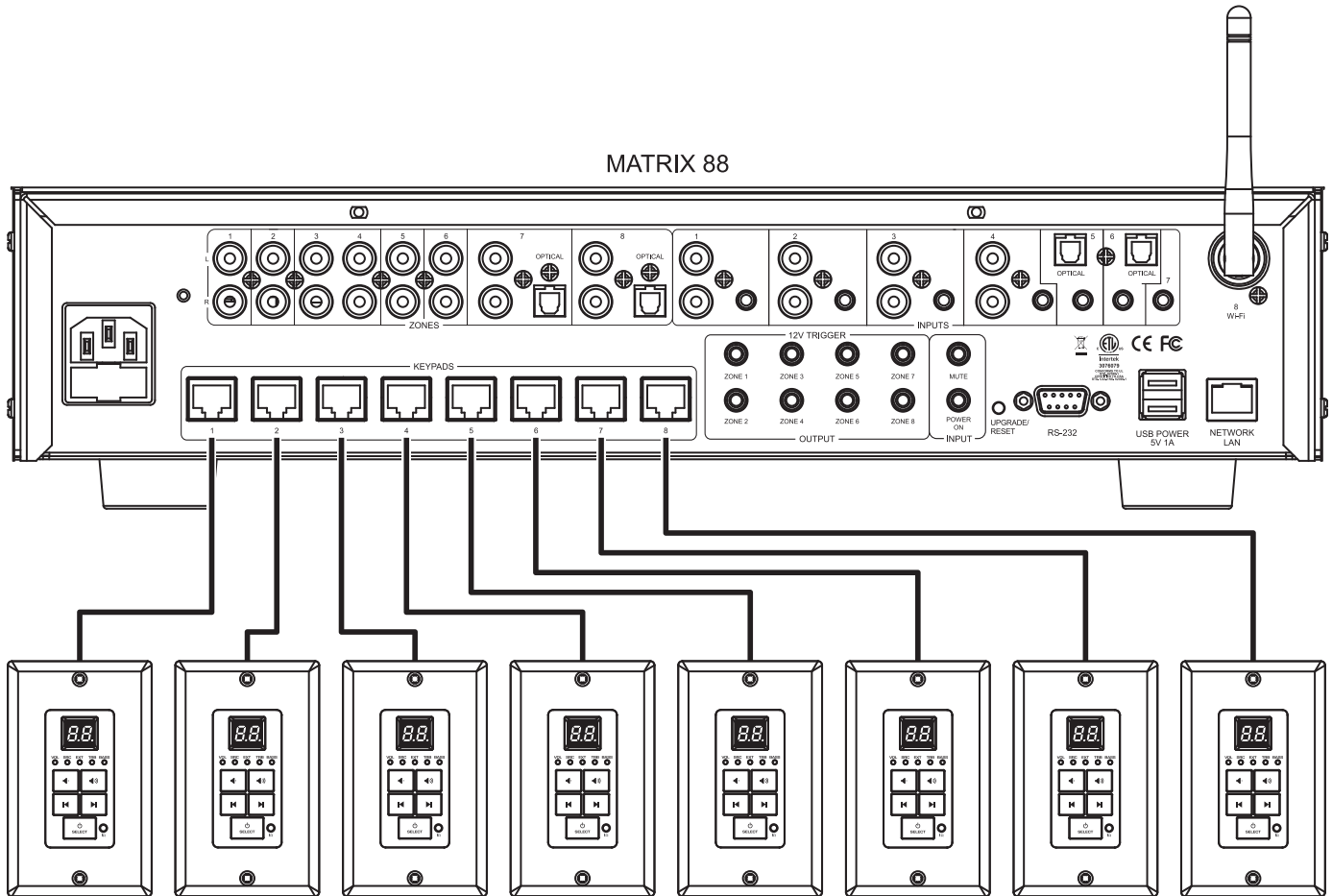

DAX88KP - Keypad

Installation – Networking

Networking

The Matrix88 is a network-based device. Connecting the Matrix88 to your network will enable Wi-Fi streaming, and also app control of the system's zones with the Dayton Audio Matrio Control app. Connecting the Matrix88 to your network is often as simple as plugging it directly into your network router or a network switch. Although it is possible to connect the device to your network over Wi-Fi, only use this method if it is not possible to hardwire the Matrix88 directly to your network.

Notes

- 1) Dayton Audio **CANNOT** guarantee the stability of your wireless network. The Matrix88 depends heavily on a high quality and robust wireless network for proper function of the mobile Matrio Control app and for Wi-Fi audio streaming. Even if you connect your device to the network with an ethernet cable, you must still have a properly configured, strong wireless connection for your mobile device in order to wirelessly control the unit with the mobile app.
- 2) If you choose to connect your Matrix88 wirelessly to your network with Wi-Fi instead of a hardwired ethernet connection, it will require a 2.4 GHz Wi-Fi network. If you follow the recommendation to hardwire your Matrix88 to your network, you can skip this note. The typical Wi-Fi network is setup so the 2.4 GHz network is named the same as the 5 GHz network, and switching is automatic within your router. Some networks are setup so these networks have separate names. For example, you might have networks "MyWi-Fi 2.4 GHz" and "MyWi-Fi 5GHz", and you will generally have your mobile device connected to the 5GHz network in this case. If this is your network, you will want to connect your Matrix88 to the 2.4 GHz Wi-Fi during the setup process. In most cases, the Matrio Control app and Wi-Fi streaming will still work correctly while your mobile device is connected to your 5 GHz network, however this depends on your specific network configuration.
- 3) Do not connect your Matrix88 unit to your network over a wired ethernet connection **AND** through Wi-Fi at the same time as this could cause the Matrix88 to experience dropouts. If you experience this issue, hold the upgrade button on the back of your Matrix88 until you see the LEDs flash. This will factory reset the unit. See the factory reset section of this guide for more details.

Installation – Networking

Wired Connection - Recommended

Wire the Matrix88 to your network using a standard ethernet patch cable connected to the RJ45 (ethernet) jack on the back of the Matrix88 device labeled “Network”, and connect the other end to your internet router / switch. Once this connection is correctly made, your Matrix88 will be ready to connect to the Matrio Control app on either Android or iOS after just a few moments. Make sure that you are connecting your Matrix88 to the same network that your mobile devices are on. The Matrix88 should be on the same virtual LAN as the device that you will use to control it with (phones, tablets, etc).

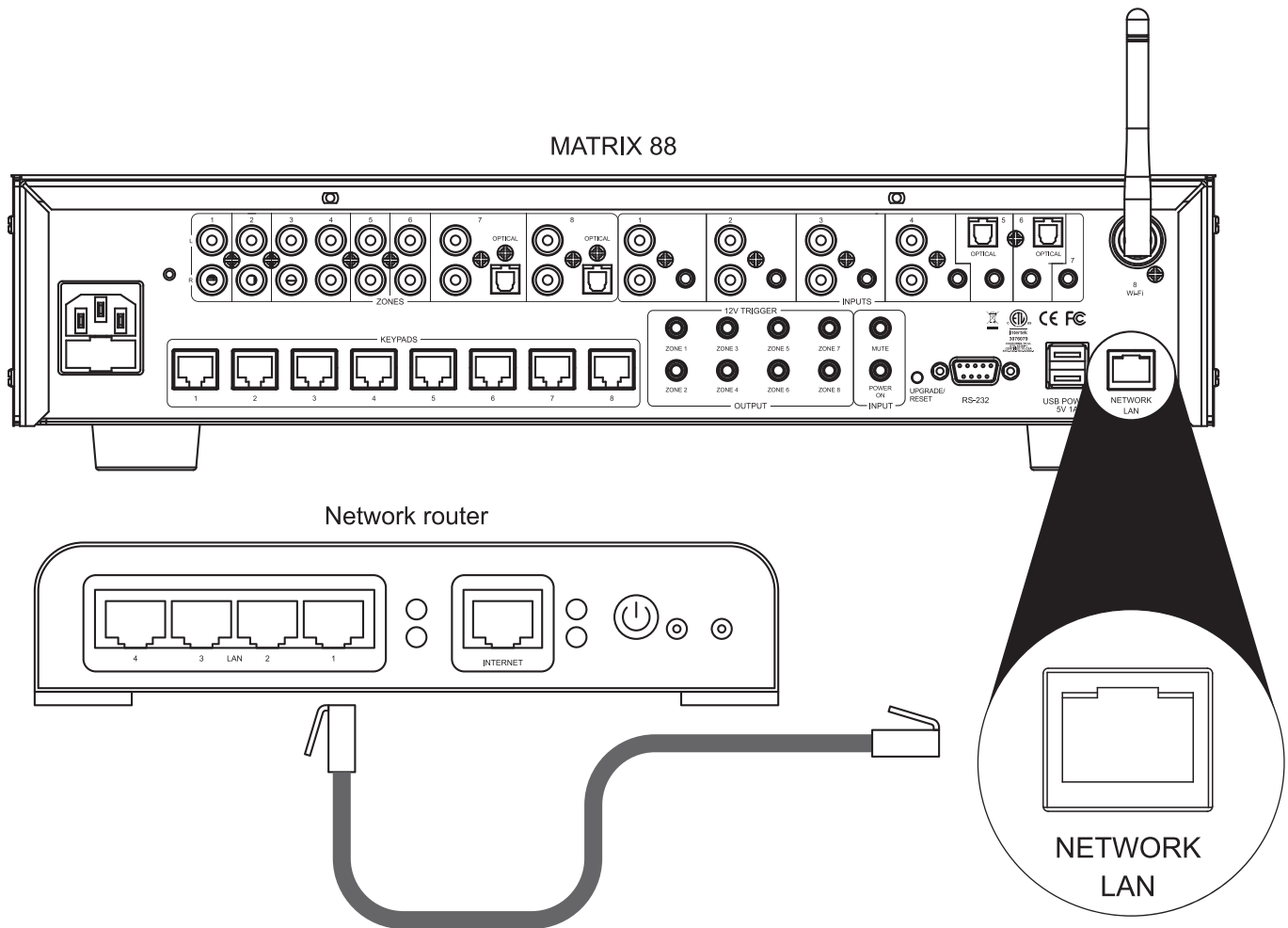

Installation – Networking

Wireless Connection

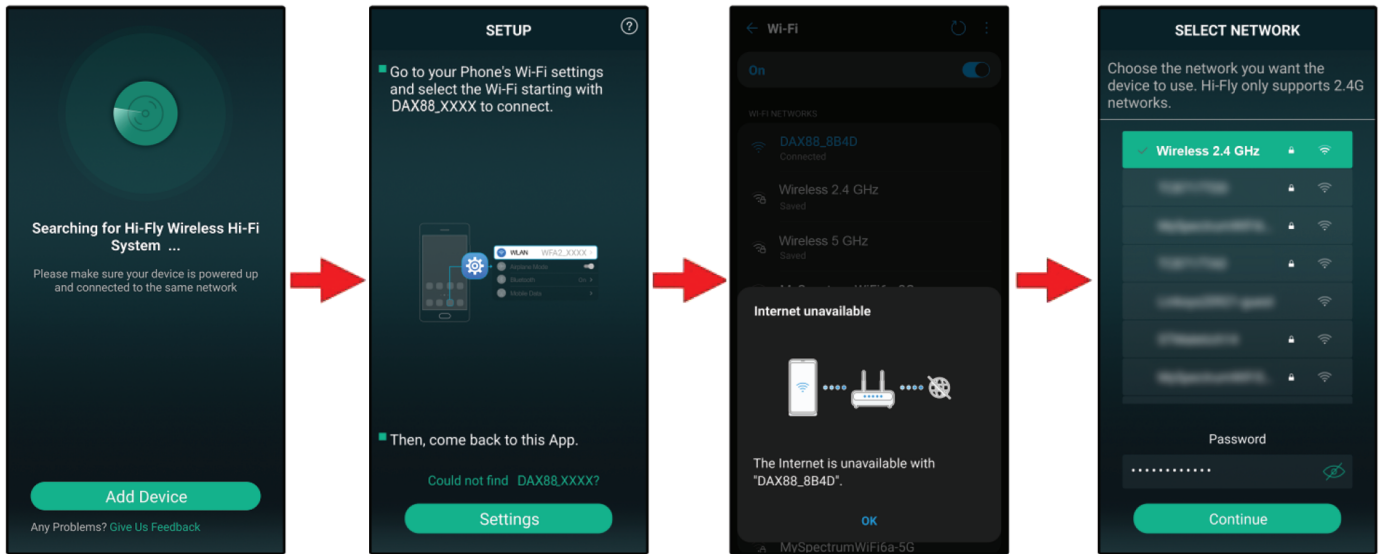

Step 1: Download and install the “Dayton Audio Hi-Fly” app from the app store. Open the Dayton Audio Hi-Fly application. Note: Hi-Fly can be deleted once these steps are complete, however it can also be used for streaming audio to your Matrix88.

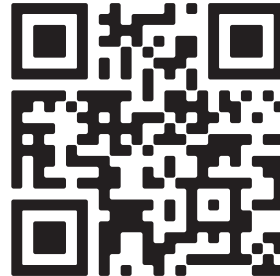

Step 2: Press the “Add Device” button as shown in the diagram above. If you already have a Hi-Fly device configured on your network, press the ‘+’ button in the top right corner of your screen to add the Matrix88.

Step 3: As prompted by the app, press the provided settings button shortcut on the screen. This will take you to your phone or tablet’s Wi-Fi setup screen (this will look slightly different, depending on if you are on iOS or Android)

Step 4: Within your Wi-Fi settings, you will be temporarily connecting to your Matrix88’s internal Wi-Fi network during setup. Find the network called “Matrix88_XXXX”, where “XXXX” is a unique identifier for your specific Matrix88. You will likely be prompted with a message that tells you that internet is unavailable with this network – that is expected, because the connection is only temporarily used in setup, and you will later switch back to your normal Wi-Fi network.

Note: If you are not seeing a Matrix88 Wi-Fi network, try first moving closer to your Matrix88. If that does not work, restart your Matrix88 by powering it off with the switch, waiting 30 seconds, and turning it back on.

Installation – Networking

Step 5: Re-open the Hi-Fly app. You will now be prompted to select your Wi-Fi network and enter the password. This step is done so that the Matrix88 can be connected to your Wi-Fi network, in the same way that your phone or laptop would be.

Step 6: Assuming all previous steps have been completed properly, you will be prompted to give your Matrix88 a custom name. Skip this step for now. If you would like to customize your Matrix88 name, please instead complete this step in the Dayton Audio Matrio Control app.

Step 7: Your Matrix88 is now connected to your network via a wireless, Wi-Fi connection, and is available for total control in the Dayton Audio Matrio Control app, and also available for wireless streaming. Your phone should automatically switch back to your original Wi-Fi network (“Wireless 2.4GHz” in this case), however if it does not, enter your Wi-Fi settings menu and select your network. Always make sure your phone or tablet is connected to the same network as your Matrix88.

Installation – Triggers

Using the 12V Input/Output Triggers

The Matrix88 offers both input and output 12V triggers, which can be useful for automation of your system. 12V triggers are an industry standard and can be found on many devices. As the Matrix88 only distributes audio and requires external amplification to power your speakers, a common use case for a zone's output trigger is turning on an external amplifier when a corresponding Matrix88 zone turns on. All connections should be made with a 3.5mm mono cable (tip-sleeve), and connect all signals as tip positive.

- The first set of triggers labeled “output” will output a 12V signal that corresponds to a zone being on or off. For example, if you wire a cable to the 3.5mm port for Zone 1's trigger, you will get a 12V signal on that wire when the zone is on, and 0V when the zone is off. This 12V signal can be useful for turning on other equipment automatically like a projection screen, lights, or an external amplifier.
- The second set of triggers labeled input contain two different functions.
 - The mute trigger will mute all zones if it receives a 12V signal, but it will unmute once the 12V signal is removed. This trigger will take precedence over any mute settings you make in the Dayton Audio Matrio Control app, keypad, or with the IR remote.
 - The power on trigger will turn on all zones if it receives a 12V signal. Zones will stay on even after the signal is removed. For example, if a 12V signal is applied to the power on trigger, all zones will turn on. When the 12V signal is removed, the zones will stay on until standby or they are manually turned off.

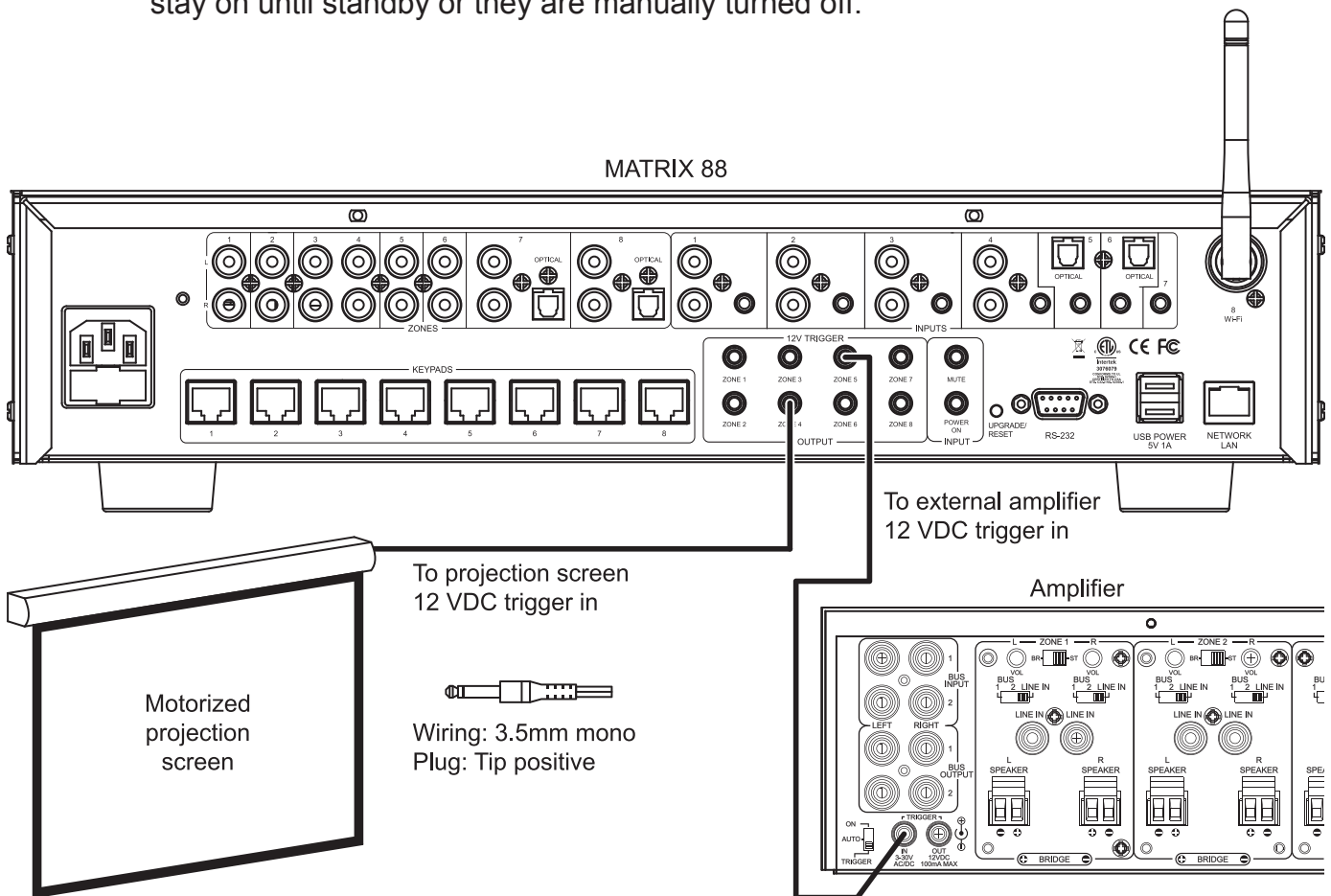

Installation – Additional Notes

Additional Notes

- 1) Consider dedicating a centrally mounted tablet in your home or business to always run the Matrio Control app for control of your Matrix88 device. This could be especially useful in a business setting, or for allowing users not connected to your wireless network to control the audio.
- 2) Name all of your zones and inputs using the Matrio Control app immediately after installation so the Matrix88 system is easy to use for those who did not do the installation.
- 3) Give your Matrix88 a suitable custom name, especially if you are installing multiple units onto a single network. This will change the label for the device in Matrio Control, Spotify Connect, Airplay and DLNA.
- 4) Label all cables during installation.
- 5) Double check all of your connections after installation and before use. Pay special attention to the polarity of your speaker connections, meaning your positive and negative wires must connect to the positive and negative terminals of your speakers. If stereo speakers are wired 'out of phase', they will still work but will lack bass and clarity. Ensure that you do not have frayed speaker wire strands that can cause a short at the connector. See the manual for your specific amplifier for more information.
- 6) Adjust treble and bass to your liking for each zone. However, ensure that your speakers and amplifier will be able to handle any bass boost you might do at higher volumes.

Installing Multiple Matrix88 Units

There is no limit to the number of Matrix88 or DAX88 devices that can be used on a single network. The Matrio Control app will automatically find any Matrix88 or DAX88 units registered to the network (see network set up section below). The Group Control mode of the app can even control multiple zones from different Matrix88 or DAX88 units at the same time. To use multiple Matrix88 units, simply connect each of your units to the same network and the Matrio Control app will handle the rest (p.28). If you are installing multiple units onto your network, it is important to hardwire all units to your network with ethernet patch cables instead of Wi-Fi. Dayton Audio always recommend using a wired ethernet connection for your Matrix88 or any other network devices when possible, but especially if multiple units are installed. Audio inputs cannot be shared between multiple Matrix88 devices on your wired or wireless network.

App Control – Matrio Control

The Matrio Control App

The Dayton Audio Matrio Control app features convenient mobile control over all of the functions of the Dayton Audio Matrix88. The app offers two main screens for control and also a settings menu that offers extra customization.

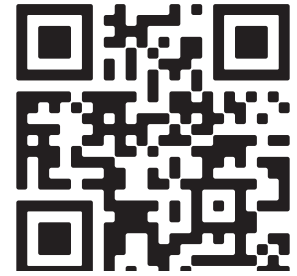

Installation

To install the Matrio Control app, simply search for “Dayton Audio Matrio Control” on the iOS or Android Google Play Store or follow the QR code above and install the app as you would any other app. The first time you open Matrio Control, it will ask you to allow permissions for finding devices on your network. It is important to accept these permissions or the app will not find your devices.

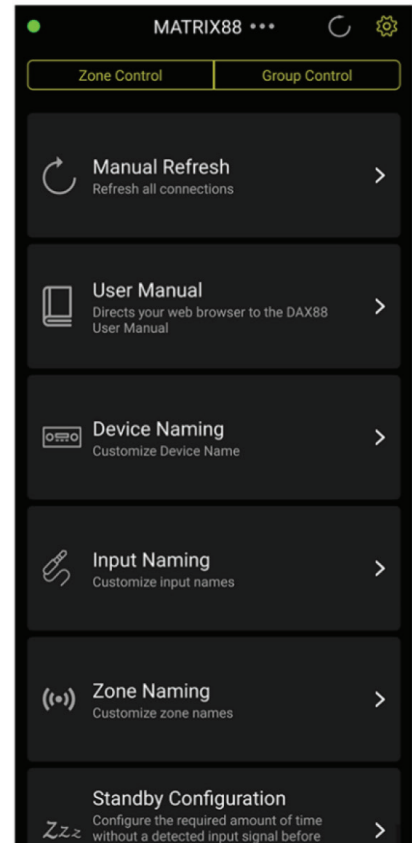
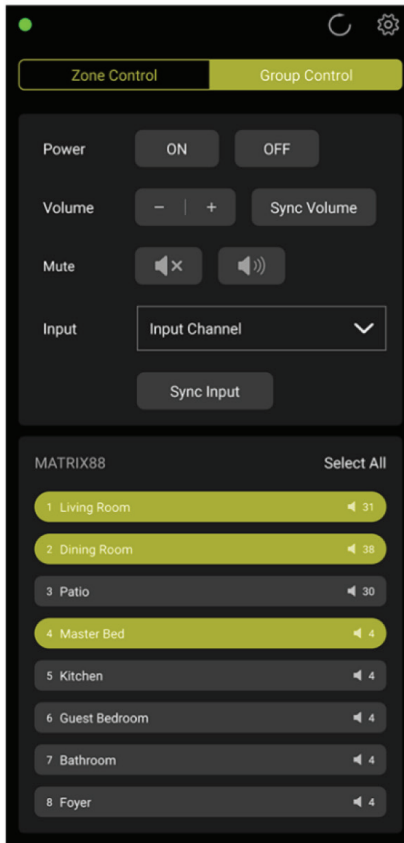
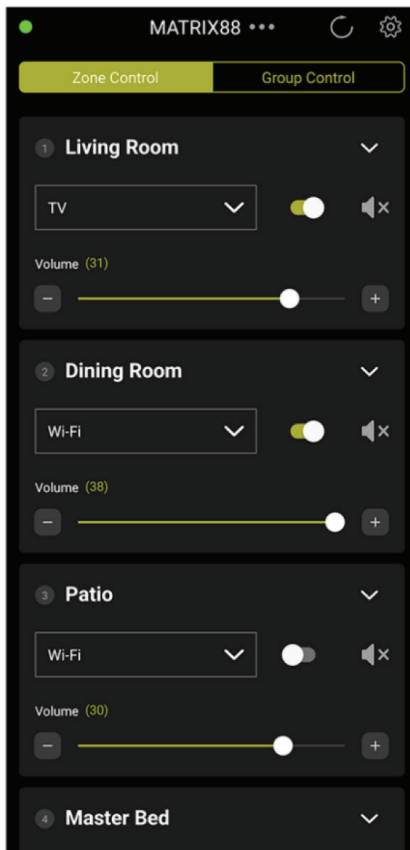

App Control – Matrio Control

Demo Mode

The Dayton Audio Matrio Control app has a built in 'Demo Mode' that allows you to explore functions of the app without having a Matrix88 or DAX88 unit on the current network. The app will say "DAX88 Demo" and function as it would if you had an actual DAX88 unit on the network. This mode can be launched if the device is not connected to Wi-Fi, or if the Matrio Control app does not find a DAX88 on the current Wi-Fi network.

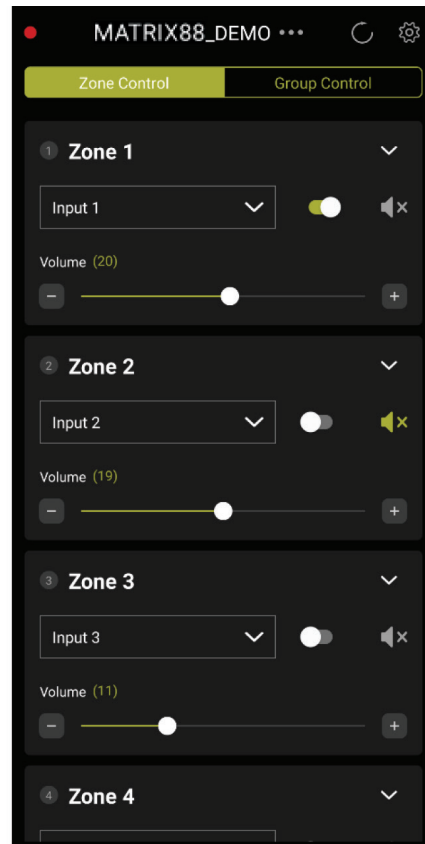
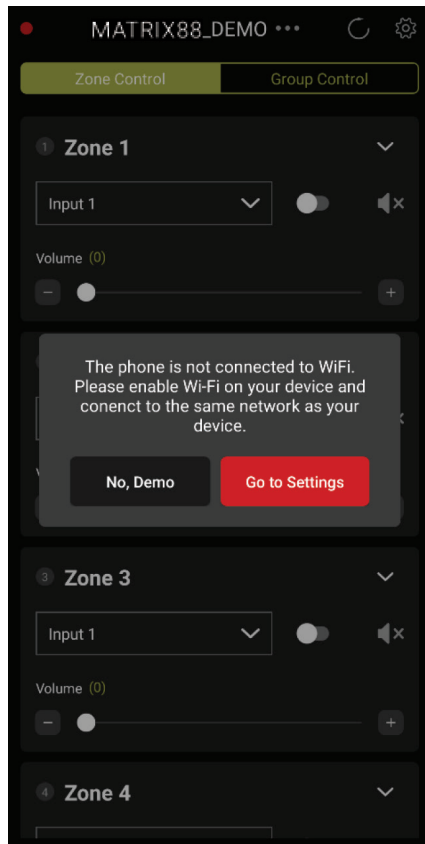

App Control – Matrio Control

Multiple Device Support

Matrio Control will automatically connect to all Matrix88 devices that it finds on your wireless network. To see a list of all of the currently connected devices, and to switch between them, press the name of the current Matrix88 or the three dots next to it as shown below. Selecting the correct device is necessary while in the zone control and settings menus. If you only have one Matrix88 unit, you will not need to use this menu.

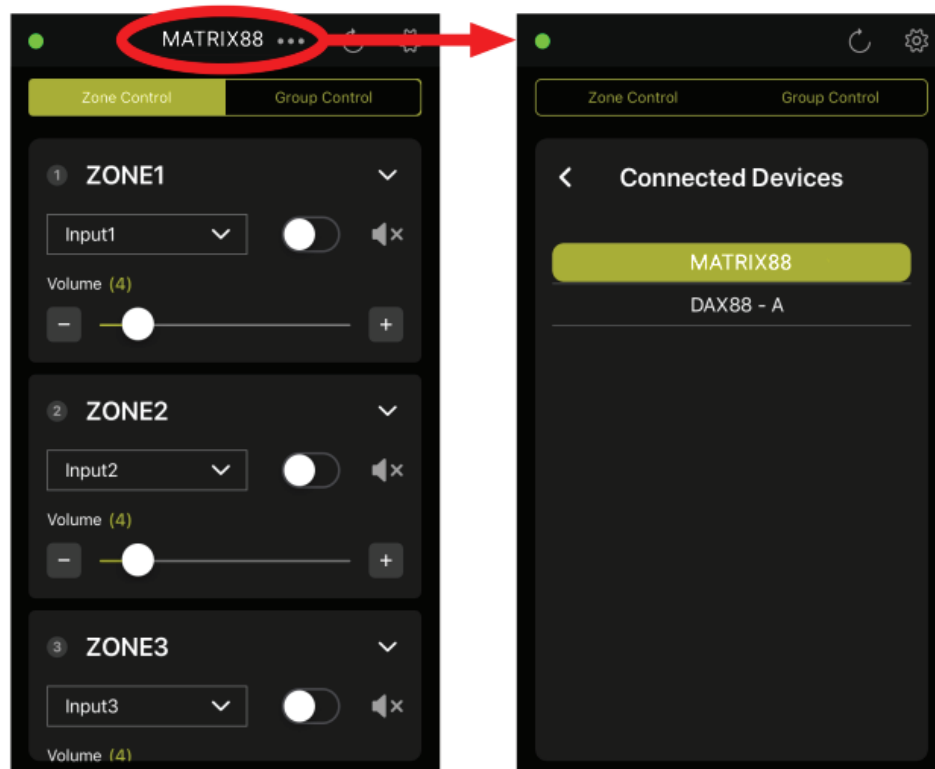

App Control – Matrio Control

Zone Control

The Zone Control menu offers control over all possible settings for each particular zone of your Matrix88. All zones of the currently selected Matrix88 or DAX88 device will be found in a scrollable list. The settings include - power on/off, input selection, volume control, mute on/off. Additional settings such as balance, bass and treble control can be found by expanding each zone's control card with the arrow button. All custom zone names and input names will appear in this menu, allowing for easier control once the device is fully setup.

Zone Number and Custom Name



Bass And Treble Adjustment



Input Selection

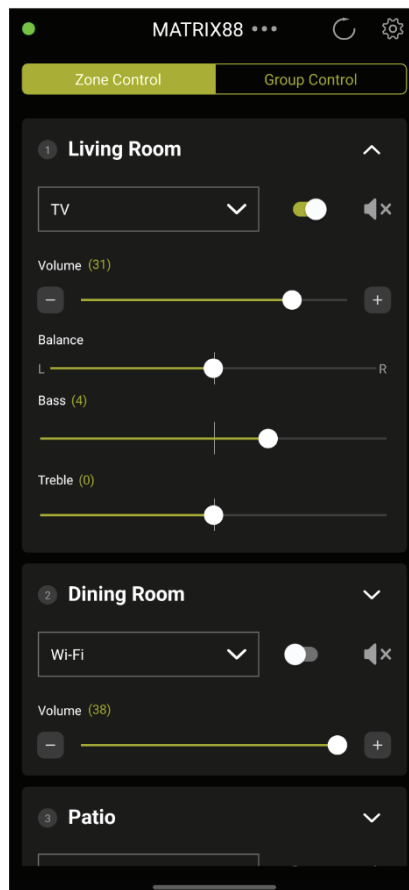

Zone Power and mute Toggle



Balance Control



Show Additional Settings



Volume Adjustment



App Control – Matrio Control

Group Control

The group control menu allows a user to send commands to many zones at once. Create a 'group' by selecting zones from the list below the command section of your screen. Once you have picked your zones, any command you pick from the top will be sent to each of the zones in your group. The app will send the command you press to all of the zones selected in the list, as if you had a remote control pointing at every zone at the same time. Note that any changes made in the Zone Control menu or from another mobile device can 'desync' your group. This mode will not attempt to keep the zones you select in sync, if you want to 'resync' a setting of your group, you must press the appropriate command from the top of the screen.

The screenshot shows the 'Group Control' interface of the Matrio Control app. At the top, there are two tabs: 'Zone Control' and 'Group Control'. Below the tabs are control buttons for Power (ON/OFF), Volume (with minus and plus signs and a 'Sync Volume' button), Mute (with a speaker icon and a muted speaker icon), and Input (a dropdown menu showing 'Wi-Fi' and a 'Sync Input' button). Below these controls is a list of zones organized into two DAX88 units. The first unit, 'DAX88 - A', has eight zones: Lobby, Office A, Office B, Conference A, Conference B, Break Room A, Break Room B, and Bathroom. The second unit, 'DAX88 - B', has eight zones: Patio, Kitchen, Bedroom A, Master Bed, Master Bath, Dining Room, Porch, and Exercise Room. Each zone has a volume indicator and a 'Select All' button. Annotations with red arrows point to various features: 'Power ON / OFF' and 'Mute ON / OFF' point to the top controls; 'Volume Adjustment Incremental or Specified Value' points to the 'Sync Volume' button and a small volume slider inset; 'Input Switching' points to the 'Wi-Fi' dropdown; 'Tap To Add or Remove a Zone From The Group' points to the zone list; 'Multiple DAX88 Units' points to the two unit headers; 'Select Zones From Any Networked DAX88 Unit' points to the zone list; 'Grouped Zones Are Green' points to the green bars of selected zones; 'Non-Grouped Zones are Grey' points to the grey bars of unselected zones; and 'Select All Zones of the DAX88 Unit' points to the 'Select All' buttons.

Power ON / OFF

Mute ON / OFF

Volume Adjustment Incremental or Specified Value

Input Switching

Tap To Add or Remove a Zone From The Group

Multiple DAX88 Units

Select Zones From Any Networked DAX88 Unit

Grouped Zones Are Green

Non-Grouped Zones are Grey

Select All Zones of the DAX88 Unit

App Control – Matrio Control

Setting up Your Device in the Dayton Audio Matrio App

The Dayton Audio Matrio Control app offers many customization options to make your Matrix88 easy to use for any user. The available customization types are device name, zone naming and input naming. All custom names get stored on the Matrix88 itself and retrieved by the Matrio Control app, so for example, if an installer sets up the names in the app during installation, anyone who uses the app after installation will see these names automatically on any device without additional setup. If multiple Matrix88 or DAX88 devices are on the network, make sure to select the desired unit by clicking the name at the top of the screen.

- 1) Custom Device Naming** – This name will help you differentiate between units if you have multiple Matrix88 or DAX88 units on your network. These names will then appear where you see “Matrix88” in the screenshots below. This name will also be your AirPlay, DLNA, and Spotify Connect name.
- 2) Custom Zone Naming** – You can give the zones on your Matrix88 or DAX88 custom names, and these names will appear in the Zone Control and Group Control menus. For example, if you install a Matrix88 in your home, you might have names of “Living Room”, “Dining Room”, “Kitchen”, “Patio”, etc.
- 3) Custom Input Naming** – Customizing input names is useful if you have many inputs going into your Matrix88 unit. Custom names prevent the need to memorize which device is connected to input 1, input 2, etc. Note that Input 8 is not customizable, as it will always be “Wi-Fi” for network streaming.
 - a. Note: If you will be using input switching across multiple Matrix88 or DAX88 devices using the group control menu, it is important to give any inputs you might have paralleled or common between devices the same exact custom name. More information can be found in the input installation section of this guide (p.17).

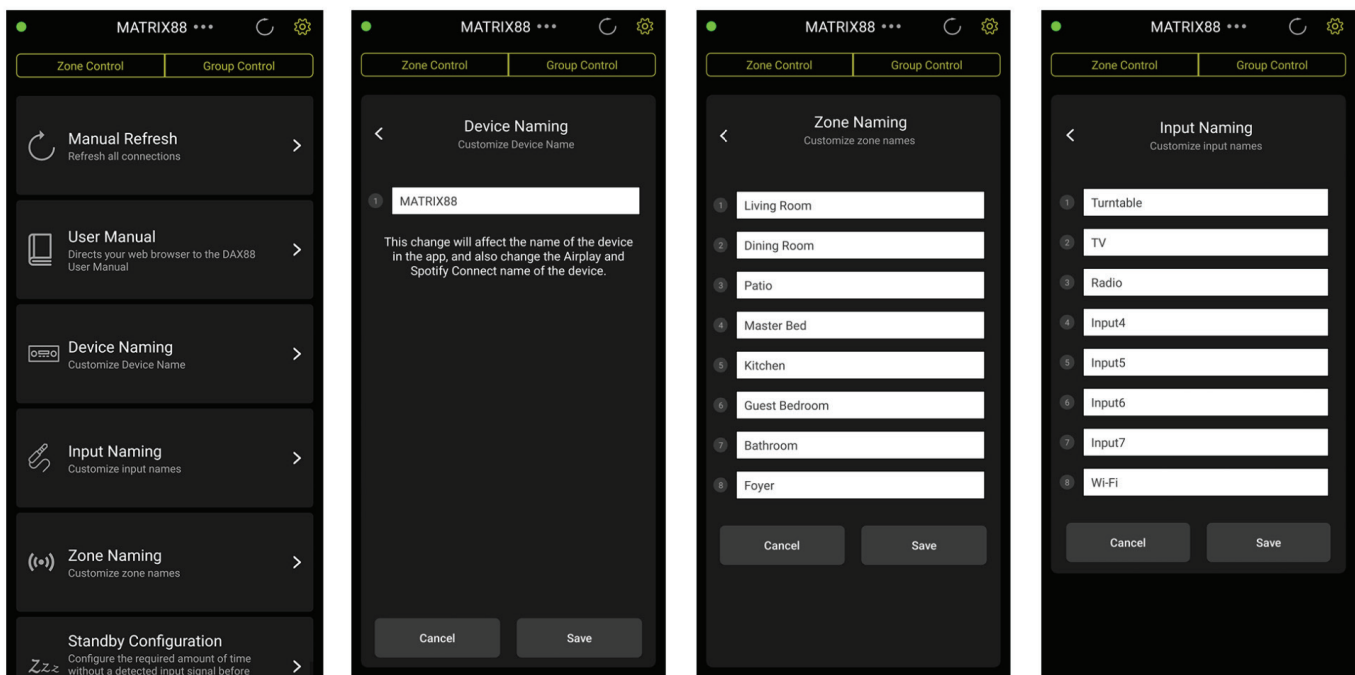

Wireless Audio Streaming

Streaming Overview

The Dayton Audio Matrix88 has Wi-Fi streaming technology built in, which allows you to enjoy Wi-Fi streaming on any or all zones of your Matrix88. There are many streaming options, but these options will vary depending on usage of an iOS or Android device as the streaming source. Make sure to set the appropriate zone of your Matrix88 to Input 8 or 'Wi-Fi' before streaming. The Matrix88 only allows one stream per unit, but this stream can be routed to any or all zones. Your mobile device must be connected to the same wireless network as your Matrix88 device before streaming. If streaming issues occur, consider upgrading your wireless networking setup and see the troubleshooting section below (p.41).

Apple AirPlay

Once connected to your network, the Matrix88 will become available as an Airplay streaming device on any Apple device connected to the same wireless network as the Matrix88. As an example, look for the AirPlay logo as circled to the right in the Apple Music screenshot. AirPlay streaming is available on any modern Apple device, starting from iOS4.2 and OS X Mountain Lion. AirPlay is the most convenient option for streaming to the Matrix88 if you use Apple products. For more information about Airplay, consult Apple's documentation about AirPlay by visiting their website.

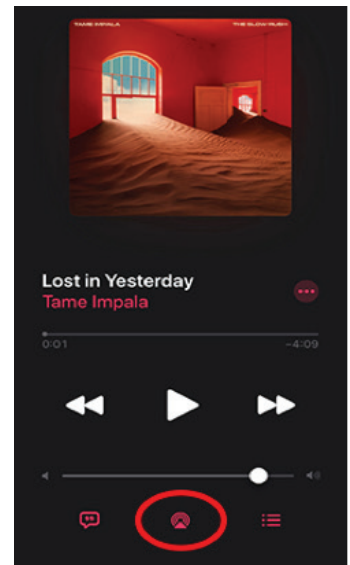

Spotify

Once configured on a network, your Matrix88 should automatically show up as an available device in the Spotify Connect menu, regardless of which platform you are using. **Spotify connect requires a Spotify Premium account**, and can be accessed by pressing the button circled to the right. This button is also available in the desktop application version of Spotify. If using an iPhone, the free version of Spotify can be used via Airplay.

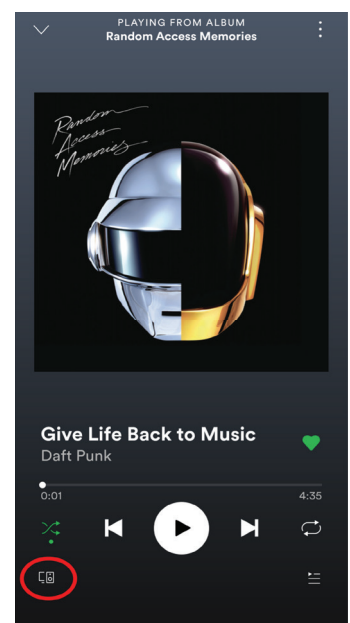

DLNA

The Matrix88 is available as a DLNA device and is compatible with any DLNA certified player / server.

Wireless Audio Streaming

Dayton Audio Hi-Fly

The Dayton Audio Hi-Fly app offers additional streaming services for use with the Matrix88. The list of the services that Hi-Fly supports can be seen in the screenshot below or within the app itself. Install the free Dayton Audio Hi-Fly application from the Google Play or iOS app store, and after launching the application you will see your Matrix88 unit as an available device (as long as you are on the same network as your Matrix88). Tap on your Matrix88 and press “browse” in the bottom left corner, and you will be given a list of steaming options as seen below.

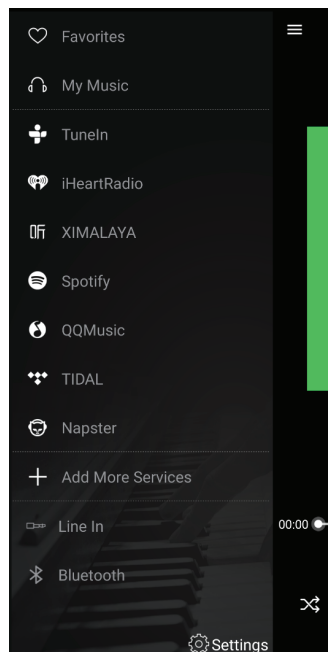
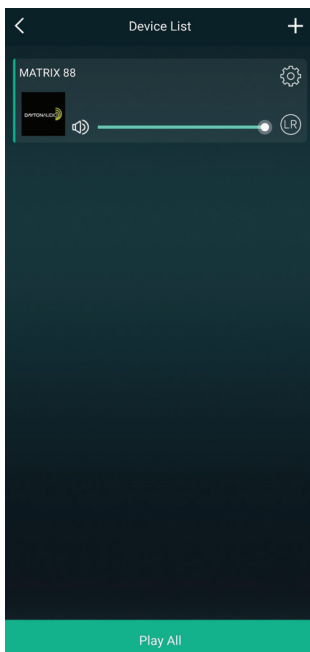

Notes

- 1) Those familiar with Dayton Audio Hi-Fly products will know that they can be grouped together in the Dayton Audio Hi-Fly app. While this is possible to do if you have multiple Matrix88 or DAX88 devices, it is not recommended as it will temporarily disable control of the non-master device(s) with the Matrio Control app while the devices are grouped (This is because it will disconnect the device from your house's / business' Wi-Fi, and connect it to the other Matrix88's Wi-Fi in order to group it).
- 2) Wi-Fi streaming is reliant on a robust network with adequate levels of available bandwidth. If the Matrix88's network connection is not strong enough, or if the wireless network is too congested, it can result in audio dropping in and out during streaming. Free up bandwidth on your network by pausing downloads, videos, or any other high bandwidth network usage. Consider upgrading your connection through your ISP and / or investing in higher quality networking equipment if this is a consistent problem. If you are having issues, and you are using an ISP provided router/modem, we highly recommend to upgrade to something better, as these provided devices are usually not up to the same quality as something bought off of the shelf for a reasonable, mid-tier price.
- 3) With the wide range of inputs on the Matrix88 and the ability to easily switch between them, external streaming devices such as smart assistants and Dayton Audio Hi-Fly devices can be easily added to the Matrix88. The included USB power ports of the Matrix88 can be used to power such devices.

Factory Reset

Factory Reset

A factory reset of your Matrix88 can be performed with the Dayton Audio Matrio Control app, or using the Matrix88's upgrade button on the unit. Factory reset will erase custom input names, custom zone names, and custom unit names. It will also erase a wireless configuration, meaning if you originally connect your Matrix88 to your network via Wi-Fi, and then factory reset it, you will have to configure the Matrix88 to your network again.

If you are migrating the Matrix88 to a new network, it is recommended to factory reset the device first.

Via Upgrade Button

To factory reset the Matrix88, simply hold the "upgrade" button while the device is turned on for 10 seconds until the LEDs on the front of the unit will flash red and blue a couple of times. Once the LEDs start to blink, you can release the upgrade button. Wait a couple of minutes, and your device will be reset to the factory defaults and ready to use again.

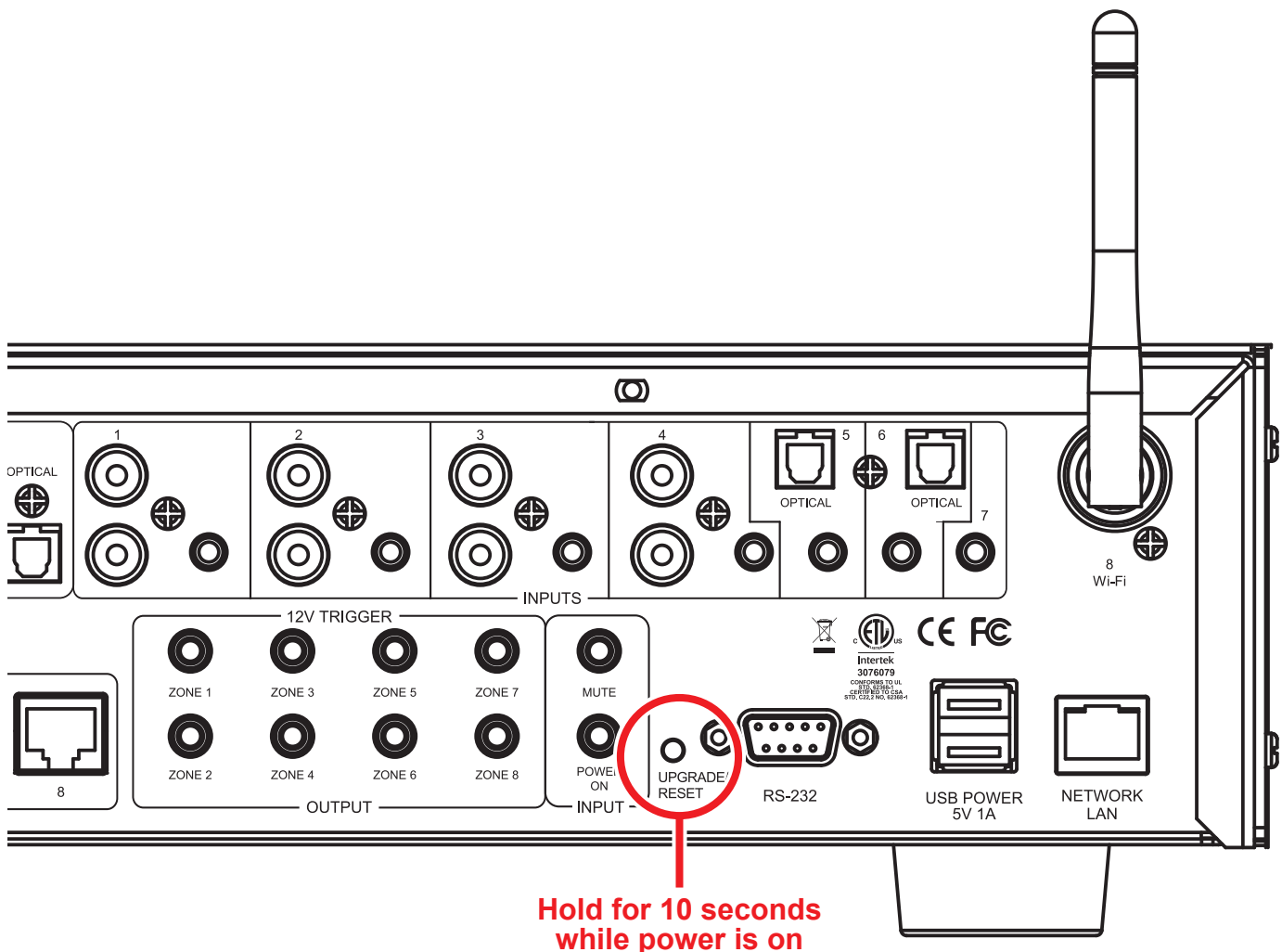

Factory Reset

Via Matrio Control App

- 1) Open the Matrio Control app on your iOS or Android device
- 2) If you have multiple Matrix88 units on your network, make sure to select the correct unit that you are trying to factory reset by selecting the Matrix88 name in the top of your screen and selecting the correct unit from the list. While in the settings menu, any changes made to settings or factory reset will **ONLY** affect one unit at a time.
- 3) Open the Settings menu by pressing the gear icon in the top right corner of your screen.

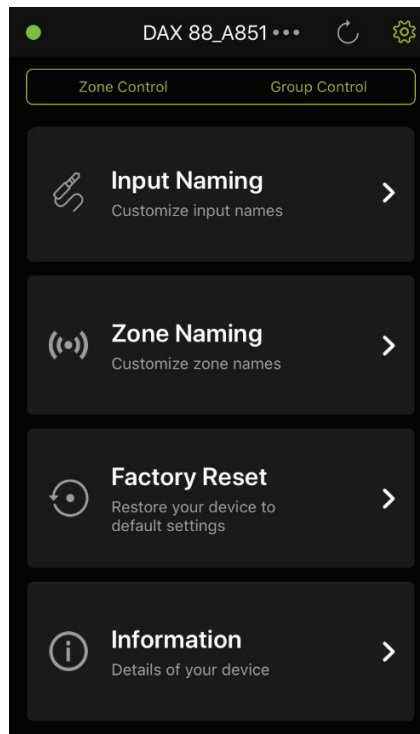

- 4) Press the Factory Reset button, and then press reset when you are sure you want to reset your unit.
- 5) You will see a message that says your Matrix88 has been reset. If you only had the single unit on your network, the app will close. If you have an additional unit on the network, the app will continue to work with the other unit.

After a factory reset, it will take a few minutes for your device to work normally again. Please allow two minutes after pressing factory reset before resuming usage of your Matrix88 or removing power. If your Matrix88 is connected to the network via a wired ethernet connection, the Matrio Control app will eventually find the unit again and display it in the app after Matrio Control is relaunched. If it does not, simply turn your Matrix88 off and then back on again after waiting the three minutes.

If your device was connected to your network using a Wi-Fi connection instead of a wired connection, it will need to be reconfigured to the Wi-Fi network (instructions can be found within this document). Consider connecting your device with a hardwired ethernet connection for more stable performance.

Standby Control

Standby Control

The Matrix88 will go into standby after 2 hours of inactivity by default, however, this setting can be changed in increments of half hours, or this feature can be turned off completely. 'Activity' in this context is defined as an audio signal being present on any input that is currently assigned to a zone that is on. For example, if music is streaming via Wi-Fi (input 8), but no zone has the Wi-Fi input routed to it, the Matrix88 will eventually enter standby. If a zone has the Wi-Fi input routed to it and that zone is turned on, the device will not enter standby.

Adjustments can be made within the Matrio Control app by pressing the gear icon in the top right corner to enter the settings menu, and then clicking "Standby Configuration".

To configure, simply select the desired standby time, and press the save button so your settings are retained.

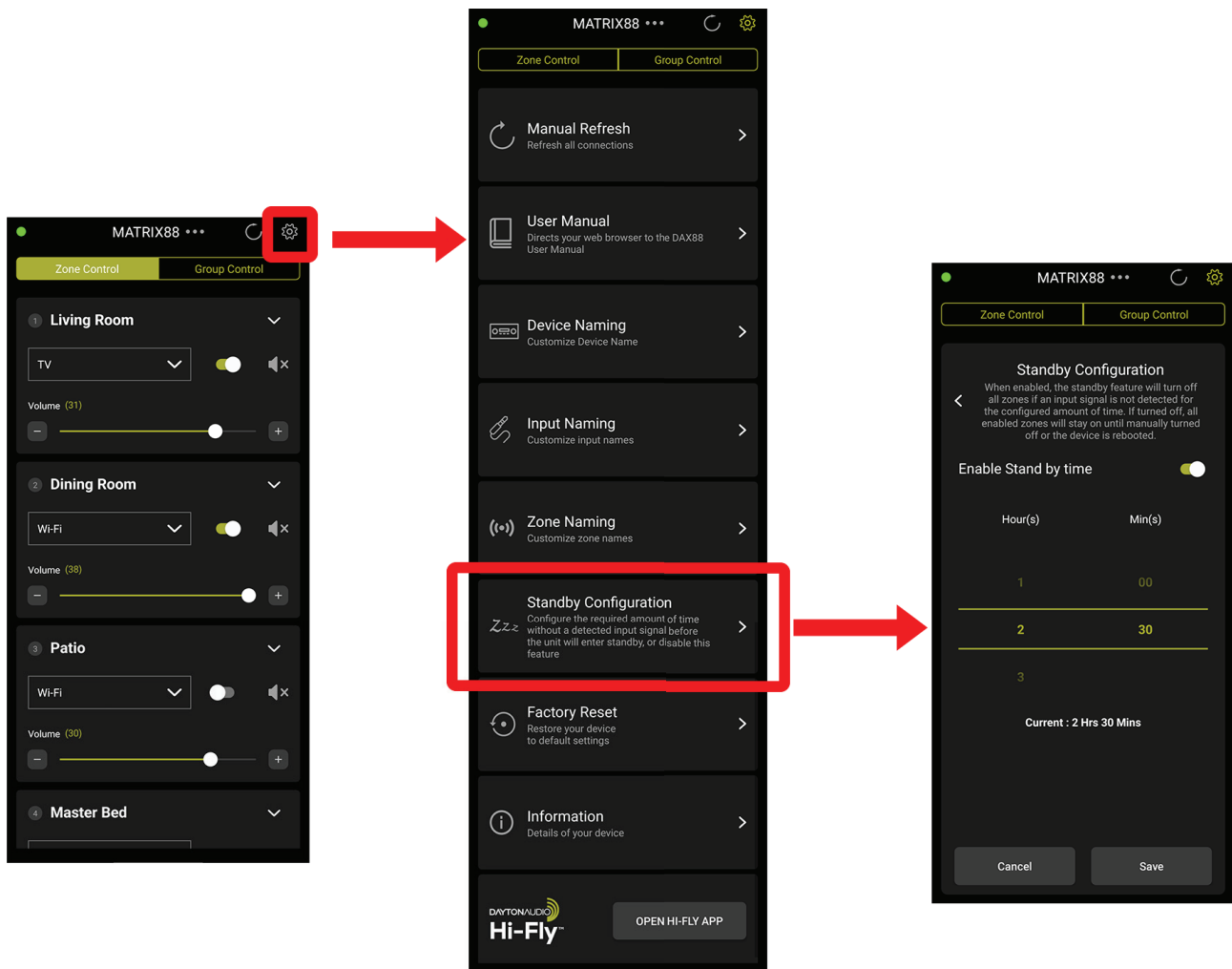

Device Specifications

Specifications

Power Consumption (Standby)	12W
Power Consumption (MAX)	60W
Power Input (AC)	100-240V 50/60 Hz (Automatic Switching)
Frequency Response	20 – 20,000 Hz
USB Outputs (Power Only)	5V 1A per USB Port
Audio Outputs	8 x Stereo RCA, 2 x Optical Toslink
Audio Inputs	4 x Stereo RCA, 7 x 3.5mm AUX, 2 x Optical Toslink
Dimensions	16-3/4" W x 9-7/8" x 4" H (425 x 225 x 103 mm)
Weight	9.37 lbs. (4.25 kg)
Bass Control	+12dB @ 100Hz (Shelf)
Treble Control	+12dB @ 10KHz (Shelf)
Wi-Fi Power	<20 dBm (EIRP)
Wi-Fi Frequency	2400-2483.5 MHz
Warranty	5 Years

RS232 Automation and Control

RS232 Control

The Matrix88 can be controlled by many home and commercial automation systems through its RS232 serial port. Included with the Matrix88 is a USB to Serial cable. The RS232 command structure and transmission specifications for the Matrix88 is detailed below. As a long used standard of serial communication, it is trivial to set up scripts that will send RS232 commands, as libraries and examples can be found for all appropriate programming languages.

Baud Rate: 9600

Data Bits: 8

Stop Bits: 1

Parity: None

Flow Control: None

'CR': Carriage Return (0x0D) is required

Control command structure <xxPPuu'CR'

xx: Zone number

01: Zone1

02: Zone2

03: Zone3

04: Zone4

05: Zone5

06: Zone6

07: Zone7

08: Zone8

uu: indicates a value that the command uses, such as 0-38 for volume control

PP: indicates one of the following control action codes

PR:Power control

PR00:Power off

PR01:Power on

MU:Mute control

MU00:Mute off

MU01:Mute on

V0:Volume control

V0(00-38):Volume control

RS232 Automation and Control

TR:Treble control

TR(00-24): Ranges from -12 to +12

Example: <01TR00 sets zone 1 treble to -12

<03TR12 sets zone 3 treble to 0

<05TR24 sets zone 5 treble to +12

BS:Bass control

BS(00-24):Bass control. Ranges from -12 to +12

Example: <01BS00 sets zone 1 bass to -12

<03BS12 sets zone 3 bass to 0

<05BS24 sets zone 5 bass to +12

BL:Balance control

BL(00-20):Balance control.

Example: <01BL00 sets zone 1 balance to 100% left

<03BS10 sets zone 3 balance to normal

<05BS20 sets zone 5 balance to 100% right

CH:Source control

CH(01-08):Source control

Examples of Various Commands :

Set Zone 1 to Power Off <01PR00

Set Zone 1 to Volume 23 <01V023

Set Zone 1 to Power On <01PR01

Set Zone 6 to Source 4 <06CH04

RS232 Automation and Control

Ask Status command structure ?xx'CR'

xx: Indicates the control object code

01 : Zone1

02 : Zone2

03 : Zone3

04 : Zone4

05 : Zone5

06 : Zone6

07 : Zone7

08 : Zone8

.....

Reply command: >xxaabbccddeeffgghhijj'CR'

aa:PA Control Status

bb:Power Control Status

cc:Mute Control Status

dd:DT Control Status

ee:Volume Control Status

ff:Treble Control Status

gg:Bass Control Status

hh:Balance Control Status

ii:Source Control Status

jj:Keypad Connection status (00:Not connected, 01:Connected)

Troubleshooting

Matrio Control will not connect to the Matrix88 even though it is set up on the network.

Carefully re-read the network connection section of this guide. If that does not solve the problem, try the following solutions.

1. The Matrix88 is not switched on or connected to power.
2. All of the permissions that Matrio Control asks for on first opening must be accepted.
3. The Wi-Fi network is not working properly or the Matrix88 is not configured to the network. The Matrix88 must be on the same VLAN as any mobile device running Matrio Control.
4. Check the network cable and other networking equipment for damage and replace as necessary.
5. The mobile device is not connected to the same network as your Matrix88.
 - a. The mobile device might be connected to different nearby Wi-Fi network, or a different Wi-Fi zone or hot spot that is not configured to be on the same VLAN as the Matrix88.
 - b. The mobile device has Wi-Fi turned off.
 - c. The mobile device is out of range of the Wi-Fi network.
6. If the Matrix88 is connected to the network with Wi-Fi, try instead to connect it to the network with a hard-wired ethernet connection. If the Matrix88 is set up with Wi-Fi, factory reset the device (p.35) after re-entering the Matrio Control app. Connecting the Matrix88 with both Wi-Fi and ethernet can cause network stability issues in the Matrio Control app. After the factory reset, the ethernet connection will continue to work and the Wi-Fi settings will be erased.
7. Try using the Matrio Control app on a different mobile device to see if the current mobile device is causing the issue.
8. Reset the Matrix88 by turning the device off and then on again after a few moments.
9. Factory reset the Matrix88 (p.35) by holding the upgrade button on the back of the unit for about 10 seconds. The LEDs on the front of the unit will blink. The reset button can be released and the Matrix88 will begin to reset. The Matrix88 can then be reconnected to the network.

Troubleshooting

The Matrio Control app frequently says it cannot find the Matrix88 unit on the network, but sometimes it connects and works fine.

This could be a symptom of a few different problems with the installation.

1. The Matrix88 is not connected to the network with an ethernet cable, but instead connected over Wi-Fi.
 - a. Hard wiring the device with ethernet to the network will usually resolve stability issues. Before or after making the ethernet connection, factory reset the Matrix88 to remove all Wi-Fi connection settings. This is necessary because connecting your Matrix88 with both ethernet and Wi-Fi can cause stability issues.
2. The Matrio Control app is being used in a location where Wi-Fi signal strength is poor.
3. There are multiple access points in the same environment as the Matrix88, and some of them are not configured to connect to the same VLAN as your Matrix88. This can occur with an improperly configured mesh network or Wi-Fi extender.
4. If multiple Matrix88 or Daxx88 units are being used, try hard wiring each of them the the network with a cable instead of using a Wi-Fi connection.
5. The mobile device has issues with its Wi-Fi antenna. This can be tested this by trying a different mobile device with the Matrio Control app in the same location.
6. The Matrix88 is connected to the network with both ethernet and Wi-Fi. If this is suspected factory reset the Matrix88 (p.35).

Troubleshooting

There is no sound coming out of the speakers.

There are many reasons this could happen. The best way to fix the problem will be re-reading and following the instructions in this guide's sections about setup, and also reading the manual of any connected amplifiers or speakers. An additional list of things to check for follows.

1. Verify the connection between the Matrix88's zone output and the amplifier's audio input.
2. Make sure the connection from the amplifier to any connected speakers is made properly. Also make sure that the amplifier is powered on and set to the correct input.
3. Verify that the desired zone being used is turned on by either using the Matrio Control app or a corresponding keypad, or by referencing the zone status lights on the front of the Matrix88.
4. Verify that the desired input is routed to the correct zone using the Matrio Control app or corresponding keypad.
 - a. If using Wi-Fi streaming, make sure the desired zone is set to **input 8**.
5. Verify that the input source is working correctly.
6. If streaming with Wi-Fi, make sure that the Wi-Fi network is working well. If a network is too congested with other traffic, it might have problems streaming music.
7. Check for any shorts in the wiring, especially in the speaker cable going from the amplifier to the speakers.

The Matrix88's Wi-Fi is password protected, but it is not configured to the desired network.

Factory reset the Matrix88 (p.35) by holding the upgrade button on the back of the unit for about 10 seconds. The LEDs on the front of the unit will blink. The reset button can be released and the Matrix88 will begin to reset. The Matrix88 can then be reconnected to the network.

Troubleshooting

Spotify Connect does not display the Matrix88 as an available streaming device.

Once the Matrix88 is configured to a network, Spotify should display it as an available streaming device, no matter on which platform it is being used (iOS, Android, Windows, Mac). If it does not, try the following.

1. Restart the device that is running Spotify.
2. If Spotify does not recognize the Matrix88, install the Dayton Audio Hi-Fly app from the Android or iOS app store. Once installed, select the Matrix88 device, select Spotify, and press “open in Spotify”. If the Matrix88 device does not appear in the Hi-Fly app, this means the mobile device is not on the same network as the Matrix88, or the Matrix88 has not been properly configured for the network.
3. If the above steps do not work, try giving the Matrix88 a different custom name (one you have never used before on any other Wi-Fi device) through the Settings menu in the Matrio Control app, making there are not two Matrix88 units with the same name. The Spotify app or mobile device might need to be restarted to make this change work.
4. As of writing this manual, usage of Spotify Connect requires a premium subscription from Spotify.

When streaming music over Wi-Fi, the sound from the speakers goes in and out / on and off.

1. Streaming dropout issues are caused by your wireless network in many cases and this is much more likely to occur if you have setup your Matrix88 to connect to your network over Wi-Fi instead of with an ethernet cable. Otherwise, make sure that the device you are streaming from (a phone, tablet) has a strong Wi-Fi signal. If the sound drops out as you move around your house or business, there are likely spots where your signal strength is poor, or someone or something else on your network is using all of the network’s bandwidth, for example by streaming high resolution video or by downloading a game. If using an ISP provided router, consider upgrading your router as they are not usually as high quality as something purchased separately. If this is a consistent issue, contact your internet provider or IT professional for options to improve your network.
2. It is possible that this is being caused by your external amplifier in a few ways.
 - a. Try turning down the volume of your amplifier, but at the same time turning up the volume of the corresponding zone in Matrio. This will result in a higher voltage signal being sent to your external amplifier, while maintaining the same volume level. Some amplifiers have filters that will consider an input signal ‘noise’ if the signal is too low. This could be especially problematic if it is mostly spoken content that you are listening to, such as radio or podcasts.
 - b. Check the speaker connections from your speaker to the amplifier. See your amplifier’s specific user manual for additional help. A loose connection could cause your audio to drop in and out, or cause the amplifier to misbehave.

Troubleshooting

My Matrix88 is not showing as an available AirPlay device.

1. Apple AirPlay is only supported on Apple devices; AirPlay will not work on an Android or Windows device.
2. Try restarting your Apple Device.
3. Your iPhone, iPad, or Mac is not connected to the same network as your Matrix88, or Wi-Fi on your Apple device needs turned on.
4. Your Matrix88 is not on or is not configured to your network.
5. Your Matrix88 is not connected to the same VLAN as your Apple device.
6. If you are sure that you are on the correct network and everything should be working properly, try giving your Matrix88 a new custom name with the Matrio app (this will change the AirPlay name) and restart your Apple device. This new custom name should be different from any other Wi-Fi device on your network.

I grouped my multiple Matrix88 units together in the Dayton Audio Hi-Fly mobile app, but now I can only see one of my Matrix88 units in Matrio.

Grouping Matrix88 devices in this way will prevent all devices that are not the master device from connecting to the Matrio app. This is because grouping your devices together connects their Wi-Fi together, and disconnects non-master devices from your wireless network. To resolve this issue, simply ungroup the devices. Look to the “Installation – Audio Sources” section of this guide (p.18) for other ways of sharing inputs between your Matrix88 devices.

All of my zones turned off after two hours of not using the device.

The Matrix88 will go into Standby mode after two hours in the absence audio input as a power saving feature. All of your zones will be turned off after this time. Standby time is configurable in the Matrio Control app, or this feature can be turned off altogether. Find standby control in the settings menu of Matrio Control, or see the standby section in this guide for more information (p.37).

I need to make changes to the settings of my Matrix88, but I do not yet have a wireless network to use (I need to use it without an external internet connection).

It is possible to control your Matrix88 unit with the Matrio app without wider internet access, which can be useful if internet connection is lost or not connected yet. Simply download the Dayton Audio Matrio app from the app store on your iOS or Android device, and then connect to your Matrix88's SSID network broadcast using the settings menu of your mobile device. You will not be able to access mobile data until you disconnect from this network, but it will allow you to temporarily control your Matrix88 by using the Matrio app.

The Matrix88 can also be controlled without a network connection at any time by using the DAX88KP Keypads or an RS232 serial connection.

Troubleshooting

My keypads do not work.

Your ethernet cables might have been terminated incorrectly. Fully reread the keypad installation section of this manual (Installation – Keypads).

1. If you have terminated your own cables, make sure that they have been crimped in the 'B' configuration.
2. **You MUST configure each keypad using the dipswitches on the back of the keypad.** For example, plugging a keypad into the third keypad point does not configure the keypad to control Zone 3. You must set the switches on the keypad. If you have multiple keypads assigned to the same zone, it will cause the Matrix88 to misbehave. See the keypad installation section for more details (p.19).
3. DAX66 or other keypads are not compatible with the Matrix88 or DAX88. Only the DAX88KP is compatible.
4. Make sure that there are no shorts. You can test the configuration using a widely available cable tester.
5. Make sure that all of your keypads are plugged into the keypads' RJ45 (ethernet style) jacks on your Matrix88, and that you have not accidentally plugged it into the networking jack.
6. Check that your Matrix88 is connected to power and switched on.

My keypads are not controlling the correct zones.

Make sure that you have configured the dip switches on the back of each keypad according to this manual (p.19). These switches are what assigns each keypad to a specific zone. Even though the connections on the Matrix88 are labeled 1-8, these dip switches must still be configured per zone for proper control with the keypads. Do not assign multiple keypads to the same zone.

Troubleshooting

Volume is not loud enough or as loud as I expect.

1. Your amplifier might need upgrading to be capable of higher power output, or your speakers. Check the volume control on your amplifier.
2. Increase the volume of the zone being used in either Matrio Control or a corresponding keypad.
3. Check the volume levels in your specific streaming app, such as Spotify, Apple Music, Hi-Fly, etc.
4. Check that you are adjusting the correct zone's volume
5. If using stereo speakers, they could be wired out of phase causing a loss of clarity and lack of bass. Carefully check that the + (red) and – (black) connections match your amplifier's output on both speakers. Refer to your amplifier's user guide for more information.
6. If using a pro audio amplifier, your amplifier might require a lot of input voltage to power your speakers adequately. Turn the volume of zone up to its maximum in this case.
7. You have wired a higher impedance load than your amplifier can drive well. For example, if you intended on wiring 2 8 ohm speakers in parallel to create 4 ohm load, if you accidentally wired them in series it would create a 16 Ohm load which is hard for most amplifiers to drive well.

The sound from my speakers is distorted.

1. The speakers themselves might be damaged or their power handling is too low to achieve the volume levels you desire.
2. It is possible that the Matrix88 is outputting a signal from the RCA Outputs that is a higher voltage than your amplifier can use without distortion. To solve this, try reducing the volume of the zone in Matrio, and then turn up the volume on your amplifier to compensate for the volume change.
3. If you are using an optical connection, check the user manual of your source device to set the audio mode to "PCM". Autodetect should work as well, but set to PCM if it is not working properly.
4. Make sure your audio source device is free of issues.
5. Try replacing the RCA cables connecting your Matrix88 to your amplifier. Bad cables can cause a lot of audio distortion that sounds like the speaker is broken.

Troubleshooting

Noise / Hum

Use only high quality cables for your system to reduce the possibility of hum and induced noise.

1. Cables routed near AC line cables and/or transformers can have noise induced into them.
2. Speaker wires run next to AC wires for long distances can have noise induced into them.
3. Electronically noisy devices (motors, etc.) are operating on same circuit or nearby.
4. Poor equipment ground. Make sure that all AC grounds are connected.
5. Make sure that all components in the audio chain are connected to the same ground.
6. Poor Quality or damaged RCA cables is a very common source of noise.
7. Check the external amplifier for damage. Try a different amplifier to see if the amplifier is broken.

Zone 'X' works, but Zone 'Y' does not work.

Try moving your amplifier connection from zone 'X' to zone 'Y'. This will allow you to evaluate if your wiring/amplifier for zone Y is wrong, or if the Zone output on the Matrix88 is bad. Check that you have routed the correct input to zone 'Y'.

Notes

Notes

Purchased on: _____

5-Year Limited Warranty
See daytonaudio.com for details



daytonaudio.com
tel + 937.743.8248
info@daytonaudio.com

705 Pleasant Valley Dr.
Springboro, OH 45066
USA