



KABD-230 / KABD-250 User Guide

The new Dayton Audio KABD series of boards leverages the convenience of Bluetooth 5.0 with aptX HD streaming along with the powerful Analog Devices ADAU1701 DSP chip to allow for almost limitless possibilities for sound customization and still have the convenience of high quality Bluetooth streaming. Out of the box, basic customizations and volume control can be made by attaching the optional potentiometers, but to unlock the full potential of your amplifier, attach an ICP1 or KPX programming board to program your KABD amplifier with the SigmaStudio development tool from Analog Devices. This allows for limitless possibilities of EQ, limiting, bass enhancement, delays and more.

This guide applies to the KABD-250 and KABD-230, which are 2-channel amplifiers that are identical in function, with the KABD-250 being capable of 2x50 Watts, and the KABD-230 being capable of 2x30 Watts. The only visual difference between the two is a large round heatsink in the middle of the KABD-250, and the KABD-230 does not have this heatsink.

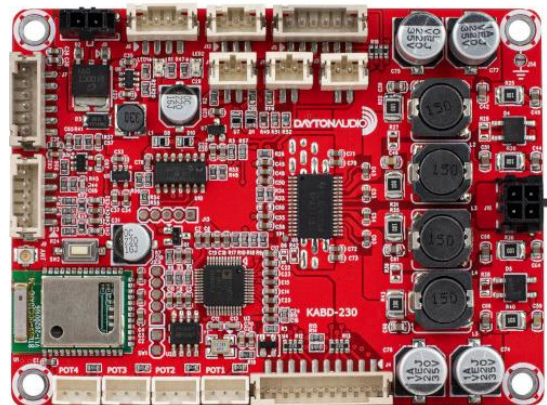

Table of Contents

KABD-250/230 Visual Overview	4
Quick Start and Wiring Guide	5
Before You Start	5
Power Supplies.....	5
Input Devices.....	5
Speaker Output and Line Output	6
Quick Start Steps.....	6
Potentiometer Headers	11
Potentiometer Port Configuration in SigmaStudio.....	12
Using the Potentiometer Ports for Connecting Buttons or Switches	12
Sigma Studio Connection - Quick Start	13
Default Register Configuration in SigmaStudio	16
Writing to E2Prom – Burning Custom SigmaStudio Programs to Non-Volatile Memory	17
Example Projects for the KABD-250 and KABD-230	19
Portable Bluetooth Speakers, Boomboxes	19
Desk Speakers	19
Gaming/Arcade Machines, Kiosks or other commercial systems.....	20
Example SigmaStudio Projects.....	21
SigmaStudio Programming Guide	21
KABD-250 Specifications	22
Electrical Specifications.....	22
Audio Specifications.....	22
KABD-230 Specifications	23
Electrical Specifications.....	23
Audio Specifications.....	23

What is new with the KABD amps compared to the DSPB series?

The DSPB series was the first generation of DSP amplifier boards from Dayton Audio, and the KABD series builds on the success of that series by adding new features such as Bluetooth 5.0.

1. Potentiometers have been removed from the board, and replaced with 3-pin JST ports. In the optional cable pack for the KABD series, there are 4 potentiometers with cables to connect directly to these ports, no soldering required. This allows for convenient external volume controls, filter controls and more. It also allows easy access to multipurpose pins of the ADAU1701 for other purposes.
2. Bluetooth 5.0 with AptX HD streaming. High quality Bluetooth streaming is now built right onto the board. Example projects have been updated accordingly to use this input. If your SigmaStudio project is not setup correctly, you will not hear any input when connected with Bluetooth.
3. 4 Channels of amplification! Perfect for making a stereo pair of 2-way active speakers, both of the new 4 channel amplifiers use the BT 5.0 module w/aptX HD, and also allow for external potentiometers. The boards can also be configured into 2.1 mode, or higher powered 2.0 mode. Each board is smaller than a typical passive 2-way crossover, yet you get amplification, DSP and Bluetooth built in with no passive crossovers required. Make a crossover with DSP instead!
 - a) The KABD-430 will allow for 4 x 30 Watt channels of DSP and amplification in the same compact size as any previous KAB or DSPB amplifier. Configurable as 4x30W, 2x30W+1x60W, or 2x60W.
 - b) The KABD-4100 is a larger board, but allows for up to 4 x 100 Watts of DSP and amplification! Configurable as 4x100W, 2x100W + 1x200W, or 2x200W. This amplifier can also be cascaded with a second KABD-4100 for up to 8 channels of amplification.
4. Because of the addition of a built in 5.0 Bluetooth chip in the KABD series, it is not recommended to use the KABD in combination with a KAB for additional outputs in the same way as the DSPB+KAB. It is recommended to use a KABD-4100 or KABD-430 instead for this purpose.
 - a) These additional line outputs are still accessible via J7 on the KABD-250. A 6-pin cable mates to this connector, and can be found in the optional cable pack, and can be easily be soldered to your choice of 3.5mm jacks, RCA jacks or directly to another amplifier for creating something like a SUB OUT jack, line output passthrough, etc.

What is the difference between a KABD amp and a KAB amp?

Dayton Audio's original line of amplifier boards is the KAB line, which have had numerous generations but always included class D amplification optimized for portable use and Bluetooth streaming. Compared to the KAB series, the KABD series of amps all include a dedicated DSP chip called the Analog Device's ADAU1701, which allows for connection to SigmaStudio and incredibly flexible DSP configuration such as on-the-fly tone controls, advanced bass processing, delays, etc. The previous DSPB series of amplifiers also employed this ADAU1701 DSP module, however it lacked Bluetooth support. The KABD series is like a combination of the KAB and DSPB series. The newest generation of KAB amplifiers employ the same Bluetooth 5.0 chips with aptX streaming and very similar connections, and for the first time, this generation of KAB also includes basic EQ capability with the KPX programmer (however it is not nearly as powerful or flexible as the ADAU1701).

KABD-250/230 Visual Overview

The amplifier pictured is a KABD-250, however everything is the same on the KABD-230. The KABD-230 does not have a circular black heatsink like the KABD-250.

- The location of the port name on the image below represents where pin 1 of that port is. J9 is on the left side of the Line In port below because that is where pin 1 is.

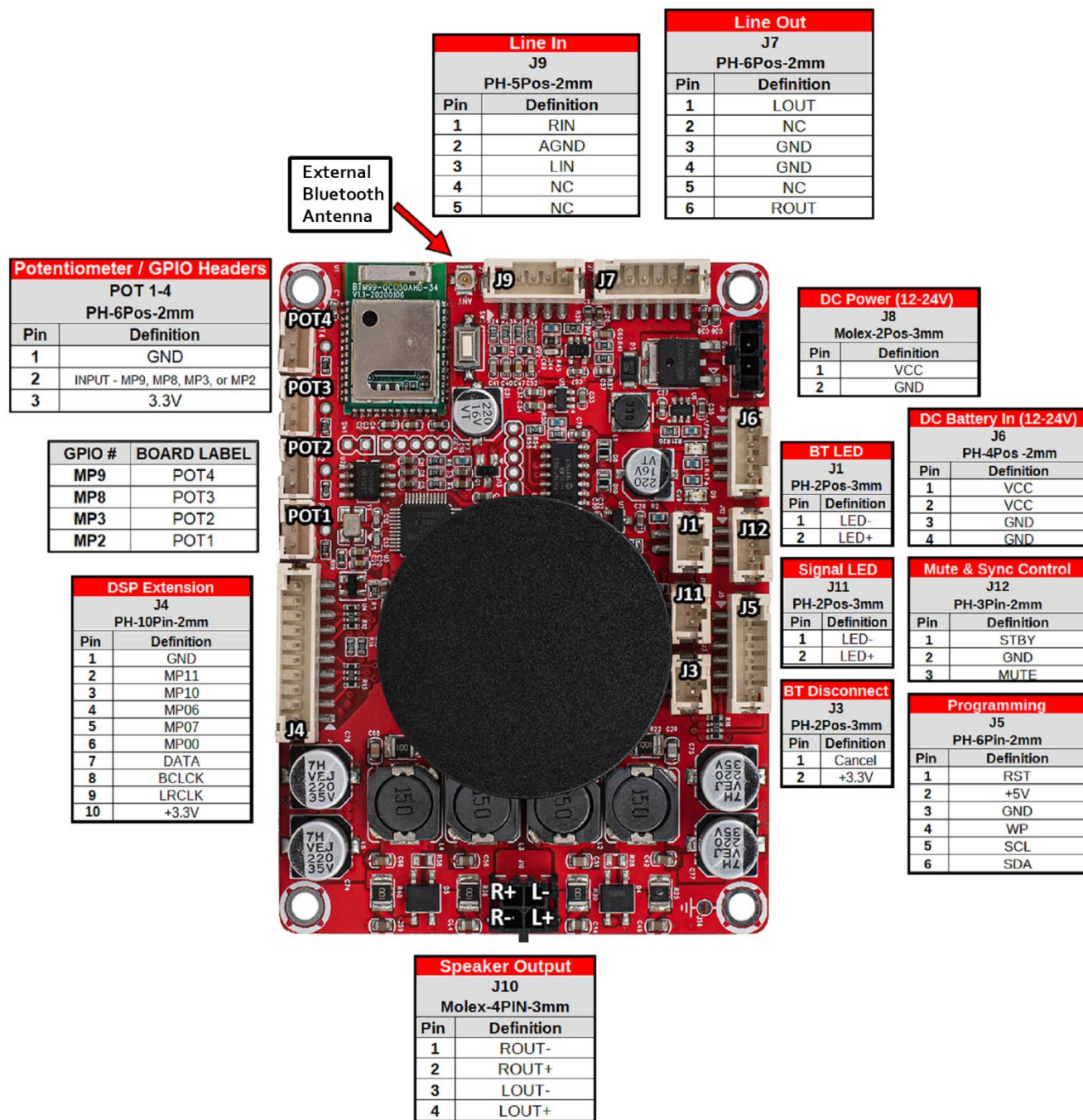

Quick Start and Wiring Guide

Before You Start

- Make sure that any speakers and input devices you plan on connecting to the KABD are working properly.
- If using SigmaStudio to use the full potential of the DSP, make sure you have purchased at least one programmer board (ICP1 or KPX), an appropriate USB cable capable of data transfer and make sure you have a Windows PC available to use for Analog Devices' free SigmaStudio software.
- Take care when attaching and especially removing jumper cables from the KABD.
 - A damaged cable can cause issues that are difficult to troubleshoot, such as noises like popping or clicking. A damaged cable can also cause programming failure.
- Note that there is a 'tips and troubleshooting' section at the bottom of this document.
- This guide will frequently reference ports on the amplifier such as "J8" or "J6". These markings are written on the board itself in small print and are usually easy to find, but if unsure, reference the quick start wiring diagram below.
- This guide is for the KABD-250/230 amplifiers, which have a built in Analog Devices ADAU1701 signal processing chip. The normal KAB (without the D at the end) amplifiers do not have this chip, and this user guide **does not apply** to these boards.
- There are separate manuals for the KABD-4100 and KABD-430, which are 4 channel amplifiers. This manual is for the 2 channel KABD amplifiers, which are the KABD-250 (2 x 50 Watt) and KABD-230 (2 x 30 Watt)

Power Supplies

- **DC Power** - The KABD-250/230 can be powered via J8 a DC power supply from 12-24V with current capabilities greater than 1A. Any power supply outside of this specification can damage the KABD-250/230. In general, the higher wattage the power supply, the more power that can be supplied to your speaker. For maximum power, use a 24V, 5A DC power supply.
- **Battery Power** - The KABD-250/230 can also be easily powered with an external Dayton Audio battery board via J6. The KABD-250/230 does NOT have a battery charging circuit on the board, so the attached battery board must have this built in. **Dayton Audio battery boards such as the LBB-3v2 (12V) or LBB-5Sv2 (21V) will work with any KABD series amplifier.** Battery modules such as the Dayton Audio KAB-BE are not compatible with the KABD series because these battery modules do not have built in charging circuits (amplifiers such as the KAB-250v4 have charging circuits on the board, but the KABD-250/230 does not have this circuit on the board).

Input Devices

- **Bluetooth** - The KABD-250/230 has Bluetooth 5.0 built directly onto the board wired directly to the ADAU1701 DSP chip via I2S. This supports apt-X, aptX-HD, apt-X LL, SBC and AAC.
- **Analog** - Analog audio sources can be input to the KABD-250/230 via J9. A 3.5mm aux-in cable is available in the KABD-SPF function cables kit for the KABD series.
 - Do not use input voltages higher than 2V or audio performance will reduce.

- **Mixing** - By default, input from I2S (Bluetooth) and J9 (analog) are mixed together within the DSP before being sent for amplification. This allows for a smooth transition between aux and Bluetooth without the user needing to touch the speaker/amplifier. This can be reprogrammed via a custom SigmaStudio project. For example, you might use a switch to change between Bluetooth and AUX (analog). See the example projects pack for an example.

Speaker Output and Line Output

- **Speaker Output** - The KABD-250/230 speaker output (via J10) is stable down to 4ohm, which means it can power almost any speaker. This also means it can power any impedance of speaker greater than 4ohm, however the efficiency will go down as the impedance goes up. Do not bridge J10, the KABD-250/230 is not intended to be bridged.
- **Line output** - The ADAU1701 DSP is capable of 4 channels of analog output with DSP applied. 2 of these channels are connected to the amplifier chip (DAC0 and DAC1 in SigmaStudio), and the extra 2 channels can be accessed as a line level output via J7 (DAC2, DAC3 in SigmaStudio).
 - This port was designed to make it easily cascaded with similar amplifiers, but a line output jack could be simply wired to J7 as well. The optional functional cable pack comes with a 6 pin-6 pin JST cable, which could be cut in half and wired to a 3.5mm or RCA jacks

Quick Start Steps

1. Speaker Connection

Connect speakers to J10 with the provided 4-wire harness according to the wiring diagram or by following the labels on the back side of the board. The ends of included wiring harness comes pre-loaded with solder to quickly connect to your driver / speaker.

Do not let wires touch while the amplifier is on. Attach the wiring harness to your speakers before connecting to your KABD.

The KABD is suitable for powering speakers and drivers with impedances from **4 Ohms to 8 Ohms**.

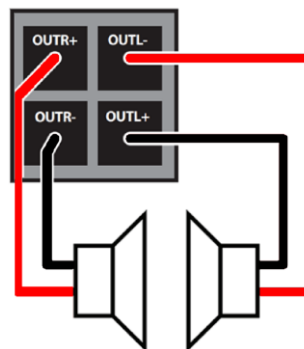
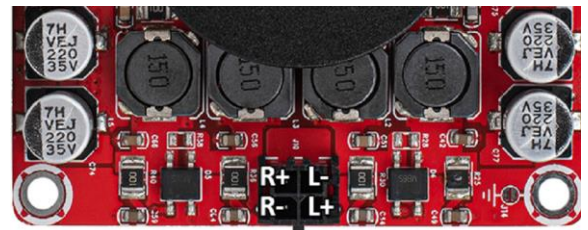

Speaker Output	
J10	
Molex-4PIN-3mm	
Pin	Definition
1	ROUT-
2	ROUT+
3	LOUT-
4	LOUT+

2. Power Options

Connect power through either J8 (4) if using a power adapter or J6 (5) if using a Dayton Audio battery board.

- It is recommended to use a power supply of **at least 12V but less than or equal to 24V**. The higher the voltage input (with adequate current capabilities), the more power the amplifier can supply to your speakers. Power supplies out of this range can damage the amplifier.
- The KABD-250/230 does not have a built-in battery charging circuit, so **a battery board such as LBB-3v2 (12V) or LBB-5Sv2 (21V) that has a charging protection circuit built in is required to use the amplifier with batteries**. If you are familiar with the KAB series from Dayton Audio, these boards include a battery charging circuit on the amplifier itself, thus the battery boards do not need to contain a charging circuit, but the KABD series need this circuit on the battery board itself.
- Connect a 2.5mm or 2.1mm DC jack to J9 to allow a variety of power supplies to be attached to the KABD-250.

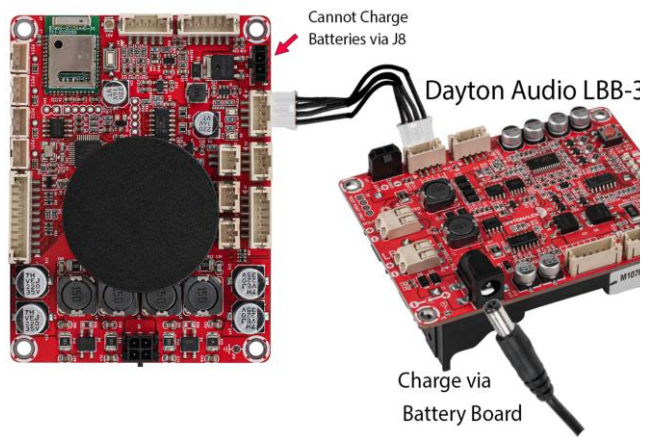
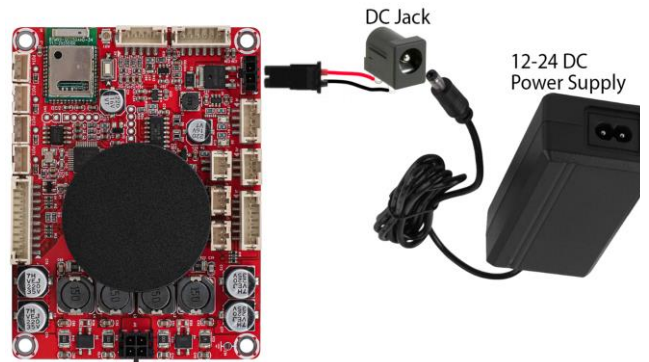

DC Battery In (12-24V)	
J6 PH-4Pos -2mm	
Pin	Definition
1	VCC
2	VCC
3	GND
4	GND

DC Power (12-24V)	
J8 Molex-2Pos-3mm	
Pin	Definition
1	VCC
2	GND

3. Bluetooth Pairing Switch

A Bluetooth pairing switch (green) that comes in the box can be added to the KABD by attaching its 2 pin connector to the corresponding port (J13). See the quick start diagram or look for the "BT Pair" port as labelled on the underside of the board.

Holding this button down for about a second will allow a new device to be paired to the KABD and will disconnect the old device. Do not hold this button for longer than 5 seconds. Use this button if you are not seeing "DAKAB" in your Bluetooth list.

Note: Only use momentary switches for the BT pairing port.

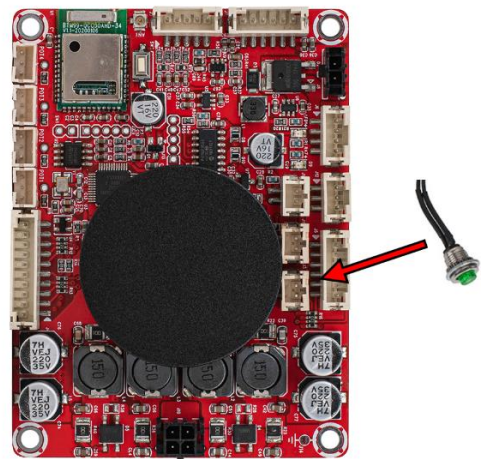

4. Bluetooth Connection

Once powered on, the board's Bluetooth connection will be available on your phone, tablet, laptop, etc and will show as "DAKAB" in your Bluetooth menu. Once connected and music is playing on the source device, audio should begin playing through your connected speakers.

Troubleshooting

1. Check that your audio source is functioning correctly and connected to the KABD's Bluetooth.
2. Check that your speaker connections match the diagram on the underside of the KABD.
3. If you had an ICP programmer attached to the KABD when the KABD was turned on, detach it and reboot your KABD.
 - a. Unpair and repair the KABD Bluetooth connection to your phone or other source device.

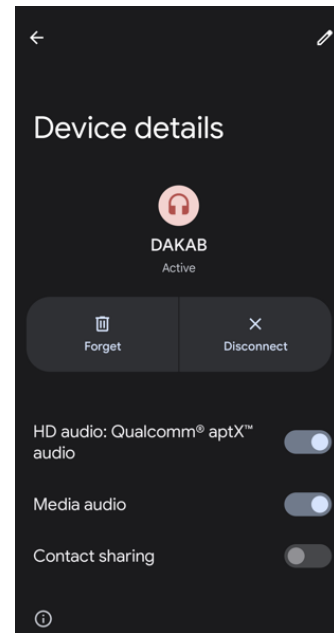

5. Signal/BT LED Connection (Optional)

Bluetooth and Signal/Status LEDs found in the functional cable kit can be added to the KABD by plugging them into the corresponding 2-pin connectors on the board. J11 is used for the Signal LED, and J1 for the Bluetooth LED.

The Bluetooth LED will blink while searching for a device, but will be solid when a device is connected.

The Signal LED will be solid when a signal is detected, however the LED will turn off if a signal has not been detected for 5 minutes, and the device will enter a low power standby mode.

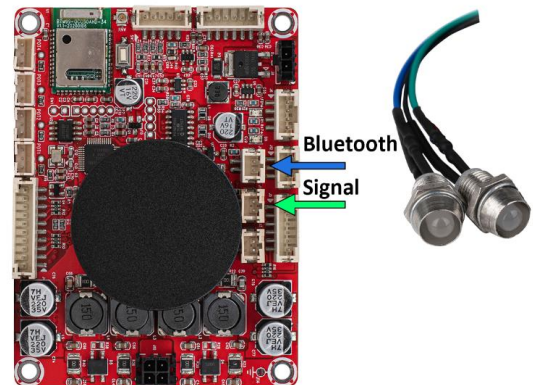

Signal LED		BT LED	
J11		J1	
PH-2Pos-3mm		PH-2Pos-3mm	
Pin	Definition	Pin	Definition
1	LED-	1	LED-
2	LED+	2	LED+

6. **Input Jack**
(Optional)

A 3.5mm jack comes included in the functional cable pack with attached 5 pin connector, which can be plugged into J9 to function as a line input for external audio sources.

This wiring harness could be modified by snipping off the 3.5mm jack, and soldering stereo RCA jacks to the cables according to the pinout on the back of the board or on the chart to the right.



Line In	
J9	
PH-5Pos-2mm	
Pin	Definition
1	RIN
2	AGND
3	LIN
4	NC
5	NC

7. **Standby Switch**
(Optional)

Included in the functional cable kit is a switch wired to a 2-pin connector that can be used as a standby switch. It should be attached to the appropriate pins of the KABD-250/230's J12 header (STBY and GND) as shown on the right.

Note: You will notice this port has 3 pins but we only use 2 pins, with the extra pin being “mute”. This port could be used to sync the standby/mute of the KABD amp with another Dayton Audio amplifier, but we do not need the mute sync when the board is used standalone. Instead we use the port to control standby mode with a switch.

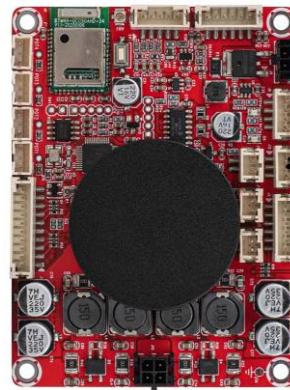

Mute & Sync Control	
J12	
PH-3Pin-2mm	
Pin	Definition
1	STBY
2	GND
3	MUTE

8. **Potentiometers**
(Optional)

Attaching the potentiometers found in the functional cable kit (sold separately) to the board in the 3-pin POT1-4 ports can allow quick on-the-fly adjustments, even without any programming. See the potentiometers section for more details. POT1 can immediately be used out of the box as an external volume control.

Numerous SigmaStudio example projects are available to reprogram the potentiometers for custom uses, such as EQ tone controls, high/low pass filters, custom volume controls, etc and can be easily customized.

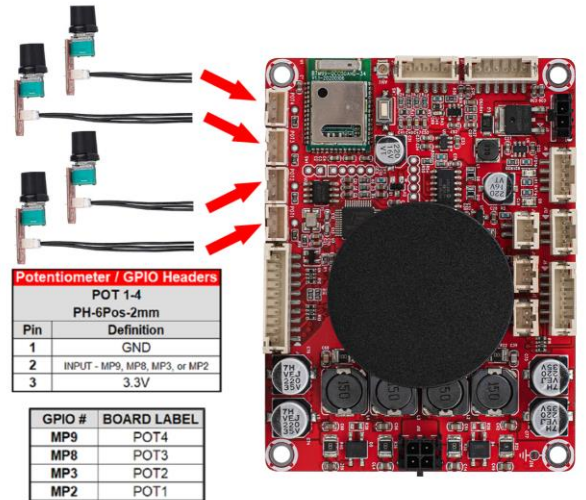

Potentiometer / GPIO Headers	
POT 1-4	
PH-6Pos-2mm	
Pin	Definition
1	GND
2	INPUT - MP9, MP8, MP3, or MP2
3	3.3V

GPIO #	BOARD LABEL
MP9	POT4
MP8	POT3
MP3	POT2
MP2	POT1

9. Bluetooth Antenna
(Optional)

Attaching the external Bluetooth antenna in the function cable kit can be helpful when the KABD is installed in situations where more range is needed, or if the Bluetooth signal is restricted, such as in a metal case.

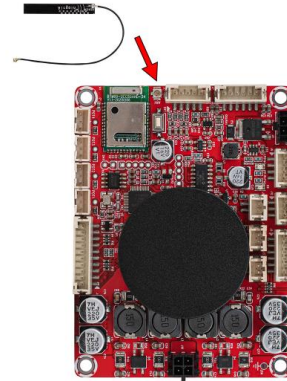

10. Line Output (2 Channels)
(Optional)

Because the ADAU1701 has 4 DAC (analog) outputs, and only 2 of them are used for the powered outputs via J10, the other 2 are available via J7. These can be wired to 3.5mm jacks, RCA jacks, or even connected directly to another amplifier, and you can even apply full DSP algorithms to these outputs via SigmaStudio.

For example, you could wire an RCA jack to this output and use it as a line level DSP'd "sub out" and connect your project to a powered subwoofer. You could also use the KABD-250/230 to power tweeters in a 2-way system, and then use this output jack to connect a more powerful external amplifier that powers the woofers.

Line Out	
-J7	
PH-8Pos-2mm	
Pin	Definition
1	LOUT
2	NC
3	GND
4	GND
5	NC
6	ROUT

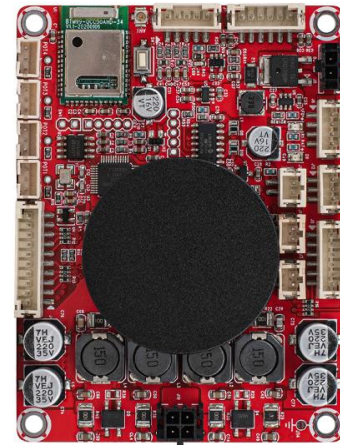

11. Programmer Connection
(Optional, but highly recommended)

Connecting a compatible programmer (Dayton Audio ICP1 or KPX) will allow you to connect the KABD's DSP chip to your PC, allowing you to create advanced DSP programs. This connection is temporary, and the programmer can be removed when finished. See the "SigmaStudio Connection" section of this document for more details.

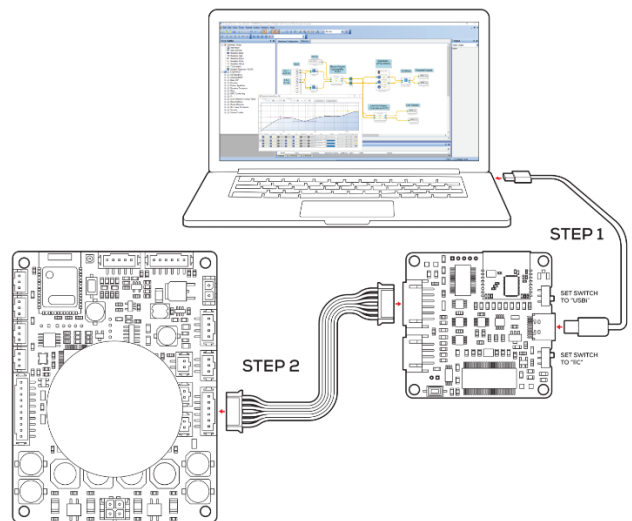

Potentiometer Headers

POT / GPIO Headers	
POT 1-4 PH-6Pos-2mm	
Pin	Definition
1	GND
2	INPUT - MP2, MP3, MP8 or MP9
3	3.3V

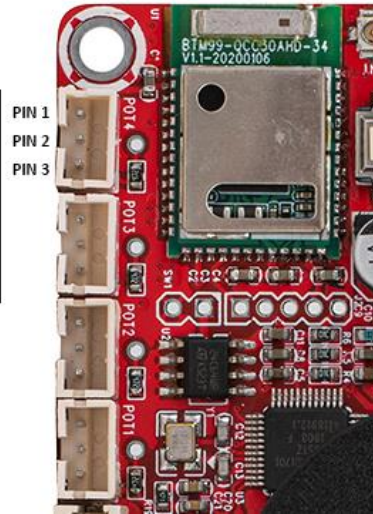

The KABD series of amplifiers come with four headers to make it easy to add external potentiometers, button, switches or rotary encoders to your project. Each of these 3-pin headers expose a voltage supply, GND, and a multipurpose pin of the ADAU1701. The optional cable pack for the KABD series comes with 4 potentiometers with cables that connect directly to these ports, so no soldering is required and they are easy to add to your project. The ports for these potentiometers are 3-pin JST headers and are clearly labelled as POT1-4. The potentiometers in the cable pack are 1k Ohm. Buttons or switches can also be easily attached to these ports and should connect to Pin 1 (GND) and Pin 2 (MP#) as labelled above and the corresponding multipurpose pin must be configured as “Input GPIO Debounce” as seen on the next page.

Out of the box, each KABD amplifier is pre-programmed for the potentiometers to have some basic functions, however there are numerous example projects for most other use cases and can be easily customized with SigmaStudio. A chart of the default potentiometer functions is below.

For instruction on how to use potentiometers or buttons/switches in SigmaStudio projects, see the “SigmaStudio for the KABD series” guide for detailed information.

Note: If the potentiometers for making on-the-fly adjustments, the potentiometers **must be left plugged in** for the changes to remain active. For example, if you use POT3 to enable a high pass filter on your speaker outputs, you must leave that potentiometer plugged in for the HPF to remain active. When you remove the potentiometers, the HPF will deactivate. If you do not want to leave the potentiometers plugged in for something like a high pass filter, you need to reprogram the board via SigmaStudio with your custom configuration.

	KABD-250/230	SigmaStudio ADC Input	ADA1701 MP#
POT1	Gain Control – J7 (Line Output)	AUX_ADC_1	MP2
POT2	High Pass Filter Control for Line Out – J7 (Line Output) <i>12dB/Octave Butterworth, 250 – 2kHz</i>	AUX_ADC_2	MP3
POT3	High Pass Filter Control for Speaker Output – J10 <i>12dB/Octave Butterworth, 250 – 2kHz</i>	AUX_ADC_3	MP8
POT4	Master Gain Control – J10 (Speaker Out) and J7 (Line Output)	AUX_ADC_0	MP9

Potentiometer Port Configuration in SigmaStudio

There is some configuration within SigmaStudio required so the ADAU1701 knows to interpret each multipurpose (MP) pin as a potentiometer input or button/switch input. Simply open the hardware configuration menu, then select the "IC 1 – 170x\140x Register Control" tab. Configure the MP pin that corresponds to your potentiometer header to "Input GPIO Debounce" for a button/switch, or "ADCX" for a potentiometer. (POT4 will actually be represented as ADC0, not ADC4).

Any example project from Dayton Audio that you use will already have this preconfigured.

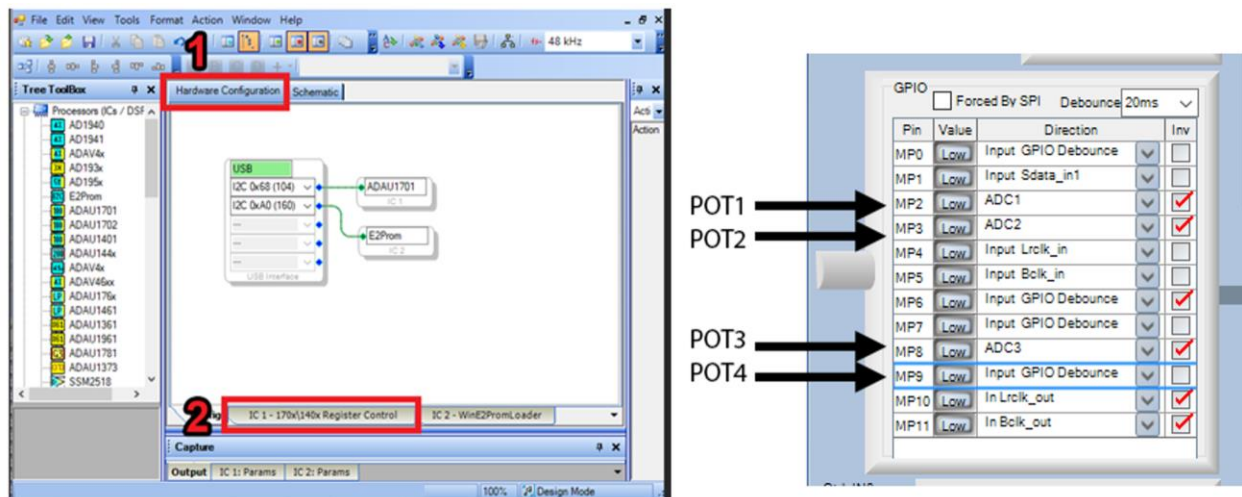

"ADC" is for Potentiometers
 "Input GPIO Debounce" is for switches

Using the Potentiometer Ports for Connecting Buttons or Switches

The 4 potentiometer ports on the boards are optimized for potentiometers, however they can be easily used to instead connect buttons or switches to the ADAU1701, as they expose 4 of the multipurpose pins of the ADAU1701. Simply connect your switch to the GND and MP pin of the desired potentiometer port (Pin 1 and Pin 2 on the diagram below). Even though these are 3 pin headers, the 2-pin connector that comes attached to the LEDs, Bluetooth pairing button, etc will also fit, just not perfectly. There is a switch that comes in the optional KABD cable pack pre-wired to a 2-pin connector.

POT / GPIO Headers	
POT 1-4	
PH-6Pos-2mm	
Pin	Definition
1	GND
2	INPUT - MP2, MP3, MP8 or MP9
3	3.3V

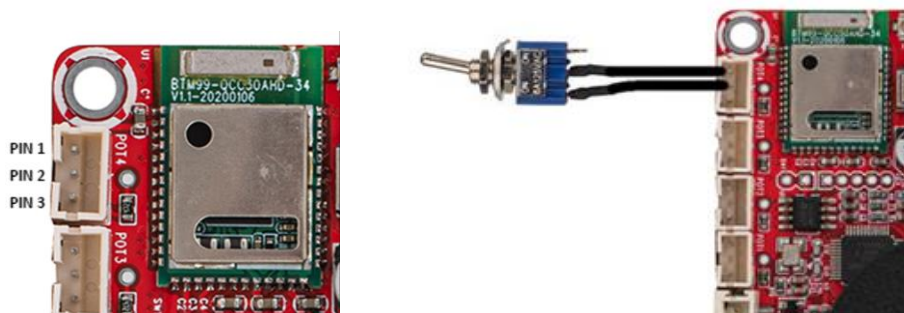

Sigma Studio Connection - Quick Start

A DSPB-ICP1 or KPX (USBi) programmer board is required to program the DSP chip on KABD amplifiers. The programmer can be thought as the bridge between the DSP chip and the computer. The programming board translates instructions from the computer controlling SigmaStudio into a signal that the KABD's ADUA1701 can understand. The programmer only needs to be connected while the device is being programmed. After programming, it can be removed and used to program as many other KABD amplifier boards as needed.

Note that a comprehensive SigmaStudio Programming Guide for the whole KABD series is available wherever you found this document (the product page for the KABD-250 or KABD-230) this section is merely to get you started with / connected to SigmaStudio. For detailed usage, read the guide mentioned above, which is intended as a learning document that goes over all details needed to make custom projects such as input routing, output routing, bass algorithms, PEQ, controllable filters with potentiometers, presets switchable with a toggle switch, etc.

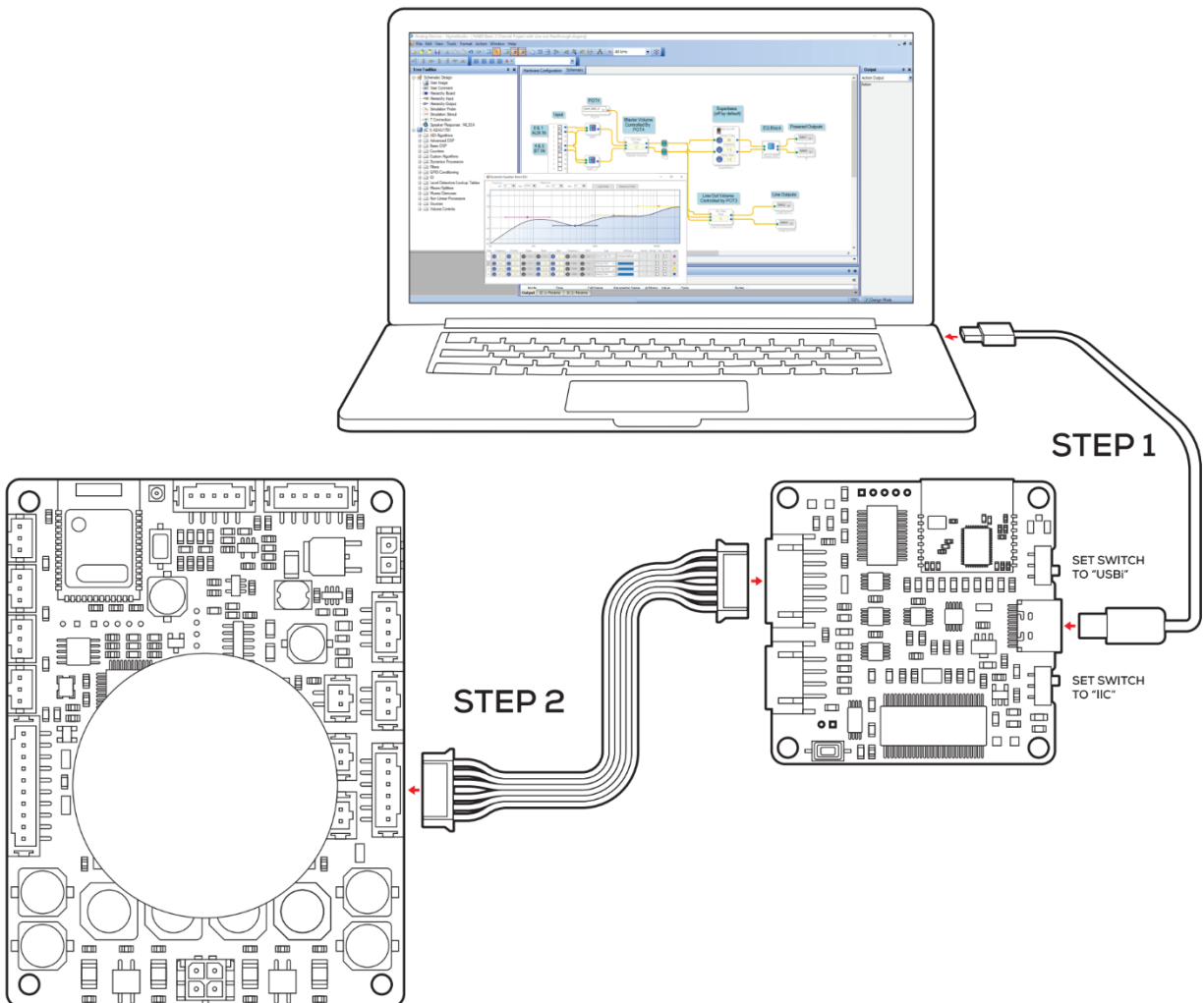

The following steps make it easy to connect your programmer to the SigmaStudio development tool, and then your programmer to your KABD amplifier. The steps require a basic knowledge of computer operation, but if the steps are followed closely, it is not too complicated. Please **complete these steps in this order** for consistent connection. Refer to the graphic above

Note: Sigma Studio connection **requires a Windows PC and an ICP1 or KPX programming board.**

1. [Download and install the most recent version of SigmaStudio to your system for free.](#)
2. Make sure your ICP1 or KPX is disconnected from USB and from your KABD amplifier before starting, to ensure the proper steps are taken.
3. Open an example project from downloadable from the Parts Express product page for the KABD-250 or KABD-230.
4. If starting a project from scratch (not recommended), open a new project in SigmaStudio by pressing File->New Project. We recommend using an example project and modifying it for your needs at least for the first time you re-program a KABD amplifier to make sure everything is working correctly.
5. Ensure that your ICP1 or KPX is **not** yet connected to the KABD. Set the switches on your ICP1 or KPX appropriately for programming the KABD.
 - a. **KPX** – Set the switches on your KPX are set to “USBi” and “IIC” for proper programming with the KABD.
 - b. **ICP1** – Set the only switch on your ICP1 to “PROGRAM” mode
6. Plug an appropriate USB cable into your programmer (micro USB cable for ICP1, USB C cable for KPX) into the PC running SigmaStudio, and then connect that USB cable to your programmer. Do not connect the 6-pin cable into your programmer until after you have connected the USB cable.
 7. If all is correct, you will see the USB block turn green, like below.

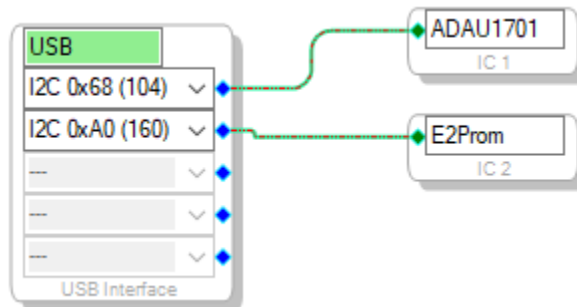

- a. Note that this block turning green means that SigmaStudio recognizes your programmer, **it does not indicate that SigmaStudio can communicate with your KABD amplifier yet.**
- b. If the connection is not successful (the block stays orange),
 - i. Disconnect all cables from the KPX / ICP1 (6-pin cable, 4-pin cable), and then plug in the USB cable to the KPX / ICP1.
 - ii. it is important to try a different USB cable, even if it's a “good cable”. Many USB cables endure a lot of abuse from charging devices, and although they might still provide power, they might have issues transferring data. Some micro USB cables might not have been wired internally to transfer data at all, and only have power wires internally.

Default Register Configuration in SigmaStudio

These are the default register settings for a KABD-250 or KABD-230 (and the entire KABD series). It is setup for proper I2S settings for Bluetooth Input, and also sets up the 4 POT ports for potentiometers (if using switches, see other section). MP2, MP3, MP8 and MP9 need to be set to ADC for usage with potentiometers. These could be set up as "Input GPIO debounce" if using buttons or switches.

If using an example project for the KABD, this will already be configured for you. If upgrading from an older DSPB project or creating a project from scratch, make sure your register settings match the screen below. If unsure, modify an example project to suit your project's needs rather than starting from scratch.

The screenshot shows the SigmaStudio Hardware Configuration window for a KABD device. The configuration is as follows:

- Audio ADCs:** Mute is disabled, Power Down is disabled.
- Serial Input:** I2S mode, LRCLK polarity is L, SCLK data change is L.
- DSP Core:** Program Length is 1x (1024 Instruct), RAM Module is 8, Zero In/Out Registers is checked.
- Serial Output 1 (channels 0-7):** Master Mode is checked, LRCLK polarity is L, Frame Sync Type is LRCLK, Frame Sync Freq is internal clock/1, MSB Position is delay by 1, Word length is 24 bits, BCLK Frequency is internal clock/1, TDM Enable is disabled.
- GPIO:** Forced By SPI is disabled, Debounce is 20ms. Pin configurations:

Pin	Value	Direction	Inv
MP0	Low	Input GPIO Debounce	
MP1	Low	Input Sdata_in1	
MP2	Low	ADC1	
MP3	Low	ADC2	
MP4	Low	Input Lrclk_in	
MP5	Low	Input Bclk_in	
MP6	Low	Output Sdata_out0	
MP7	Low	Input GPIO Debounce	
MP8	Low	ADC3	
MP9	Low	ADC0	
MP10	Low	In Lrclk_out	
MP11	Low	In Bclk_out	
- Control ADC:** Enable is checked, Forced by SPI is disabled. Input Filter is 4-bit Hyste.
- Interface Register:** Force By SPI is disabled. Register values:

Register	Address	Value
Core	2076	b 0000000011100
GpioAll	2056	b 0000000000000
RAM	2077	b 1000
SerialOut1	2078	b 011000000000000
SerialInput	2079	b 000000
MpCf0	2080	b 0100010011111111101000000
MpCf1	2081	b 1100110011111111100001100
AnalogPower	2082	b 0000000000000
AnalogInterfa	2084	b 10000000000000000
AnalogInterfa	2085	b 000000000000000

Writing to E2Prom – Burning Custom SigmaStudio Programs to Non-Volatile Memory

This step writes your custom program to non-volatile memory on the KABD amplifier. This means that the program will be retained on the KABD even after it has been powered off and then back on again. This can be reprogrammed as many times as needed. When you are programming via SigmaStudio and making changes on the fly, the program is only stored in TEMPORARY memory. It is not until you write the program to E2Prom that your custom program can be reprogrammed to the DSP as the board turns on. **If you find that your custom program is lost on a power cycle, it means you have not written the program to E2Prom.**

IMPORTANT – This step will erase the stock configuration of the board! This means that the default functions of POT1-4 will be reprogrammed or removed, depending on the custom SigmaStudio project that is burned. See the project pack for original firmware for the KABD-250 or KABD-230.

1. This guide assumes that you have successfully re-programmed your board with a custom program using the 'link compile download' button , and you are ready to burn it to the E2Prom memory (it can be rewritten as many times as desired).
2. Right click your "ADAU1701" block and click "Write Latest Compilation to E2PROM". This means it will burn the latest program you have compiled to E2Prom. This means the program that was configured the last time you pressed "Link Compile Download" or just "Link Compile Connect". If this option is greyed out, it means you need to press Link Compile Download and run a program on your KABD first.

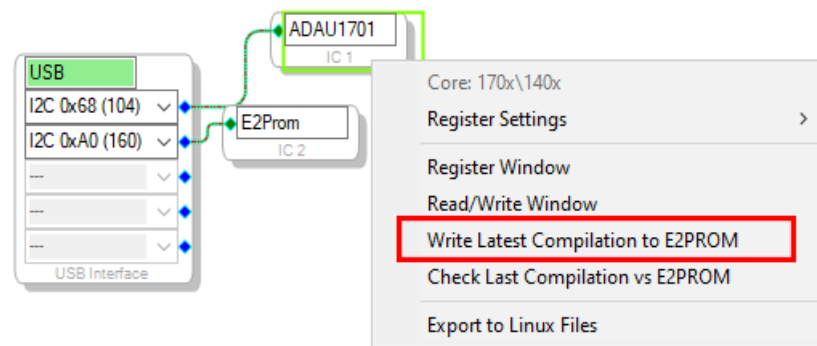

3. In the window that opens, make sure the settings match what is in the screenshot below (they are the default settings), and press OK.
 - a. NOTE: Your programmer's switch(es) need to be set properly for this step to work.
 - i. The ICP1 switch's position must be set to "PROGRAM"
 - ii. The KPX's switches must be set to "USBi" and "IIC".

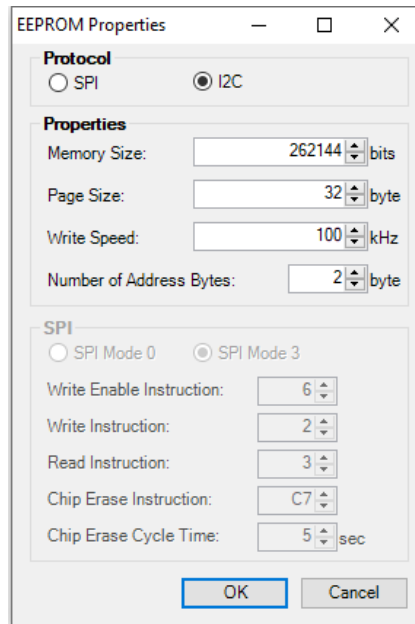

4. The program should now be written to E2PROM after it finishes programming. This means you can remove your programmer from the KABD, and your program should remain programmed on the board after power cycling the KABD.

Project Examples for the KABD-250 and KABD-230

Below are some examples of how the KABD-250 or KABD-230 could be used. Download the SigmaStudio programming guide for the KABD series and the project pack found on the product page of the KABD-230 or KABD-250 for details about how the necessary DSP programming can be achieved to achieve these projects.

Portable Bluetooth Speakers, Boomboxes

The KABD series of amplifiers are optimal for portable and or battery powered speaker projects. This is for many reasons.

- 1) Efficient class D amplification that minimizes the amount of power needed to drive your speakers.
- 2) Bluetooth 5.0 with high quality aptX HD streaming
- 3) A Battery Input Port (J6) that matches the ports of the LBB series battery boards from Dayton Audio, the LBB-3v2 (12V) or LBB-5Sv2 (21V) for easy, portable power. Using a Dayton Audio battery board takes the uncertainty out of how to use batteries for projects.
- 4) Automatic power saving operation that drops power consumption to 105mW when a signal is not detected. This ensures minimal power draw even when the speaker is accidentally left turned on.
- 5) DSP optimization of drivers. This includes things like -
 - a. Optimizing the bass output of small drivers
 - b. Protecting the drivers with infrasonic (high pass) filters, limiters, bass control, etc
 - c. Preset modes or potentiometer filter controls for on-the-fly adjustments to the sound of your speaker. For example, more treble might be desired if a portable speaker is placed on the ground away from ear level, or in an outdoor environment. However, if this same speaker is placed on a coffee table in front of the listeners, less treble might be required.

Desk Speakers

Desk speakers of all kinds can be made with the KABD-250 or KABD-230

- 1) Stereo Pair of full Range Drivers Optimized with DSP – Many full range drivers can be greatly improved if the frequency response is optimized with DSP. This could include things such as selective bass boosts, treble boosts, or even just precise filters to correct other errors in frequency response. A full range driver will usually not sound as good as a pair of 2-way speakers with a properly designed crossover, however for many situations and listeners they can sound more than acceptable. You could also use the line output capability of the KABD amplifiers to connect a powered subwoofer to get the low end that many full range drivers can lack.
- 2) Retrofitting an existing pair of desk speakers to have built in amplification and optimization with DSP. For example, you might have an old pair of 2-way speakers that already have crossovers built in. By adding a KABD-250/230 inside of the cabinet of one of them, you can remove the need for an external amplifier taking up precious real estate on your desk, and you can even optimize the sound of your original speakers with DSP, add Bluetooth or presets such as a 'night mode' that has reduced bass to not disturb sleeping family or roommates. You could also use

the line output capability of the KABD amplifiers to connect a powered subwoofer, and even add some room EQ to the subwoofer.

- 3) For creating 2-way speakers with active crossovers, a 4 channel amplifier such as the KABD-4100 or KABD-430 is better suited for this type of project because 4 channels can power a stereo pair of tweeters and woofers, but a 2 channel KABD only has 2 powered outputs.

Gaming/Arcade Machines, Kiosks or other commercial systems.

The KABD-250 or KABD-230 is an excellent choice for adding audio to systems of all kinds used for commercial purposes. Wherever there are speakers, there needs to be an amplifier. And the KABD series brings amplification, Bluetooth and DSP in one compact and easy to integrate package. The integrated DSP allows for tweaking the sound to completely suit the unique needs of a big project, and features like programmable external potentiometers and plug and play wiring harnesses bring incredible customization possibilities.

Utilizing the DSP in a commercial environment can be beneficial in many ways. For example, if we wanted to make an arcade machine with great audio to really pull the gamer into the game. We could use a pair of high quality full range speakers built into the cabinetry of the machine, and then optimize the sound of those speakers and also efficiently power them with a KABD-250 or KABD-230. With DSP integrated into your arcade machine, you can fully optimize full range drivers, which most need to sounds their best when used by themselves. It can be especially important in noisy environments, like most commercial settings are. Optimizations might include a high pass filter to ease the load on a full range driver, a small bass boost in the high bass region to increase perception of bass, a limiter to protect the drivers, a treble boost to compete with other noise sources, or even different presets with the flick of a switch or turn of a dial for different situations.

Example SigmaStudio Projects

On the product page for the KABD-250 or KABD-230, you will find a zip file that contains numerous project examples for the entire KABD series. For further descriptions of the projects, see the end of (but read all of) the “SigmaStudio Programming Guide for the KABD Series of Amplifiers” Guide. You will find pre-configured and easily modifiable projects with features such as bass enhancement, on-the-fly tone control with potentiometers, on-the-fly preset switching, 2-way speaker projects, 3-way projects and so much more.

daytonaudio.com/topic/KABD

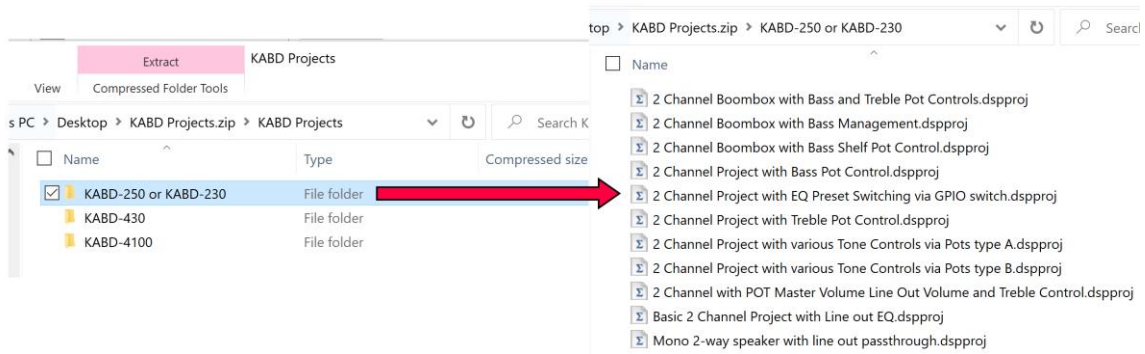

SigmaStudio Programming Guide

Look for the “SigmaStudio Programming Guide for the KABD Series.pdf” file for an extensive guide for making custom DSP programs for the KABD series of amplifiers. This guide is a learning tool, and could be used simply to figure out what to tweak in the example projects, or even for learning how to make your own projects from scratch.

Below is an example, annotated SigmaStudio program for the KABD-250 or KABD-230.

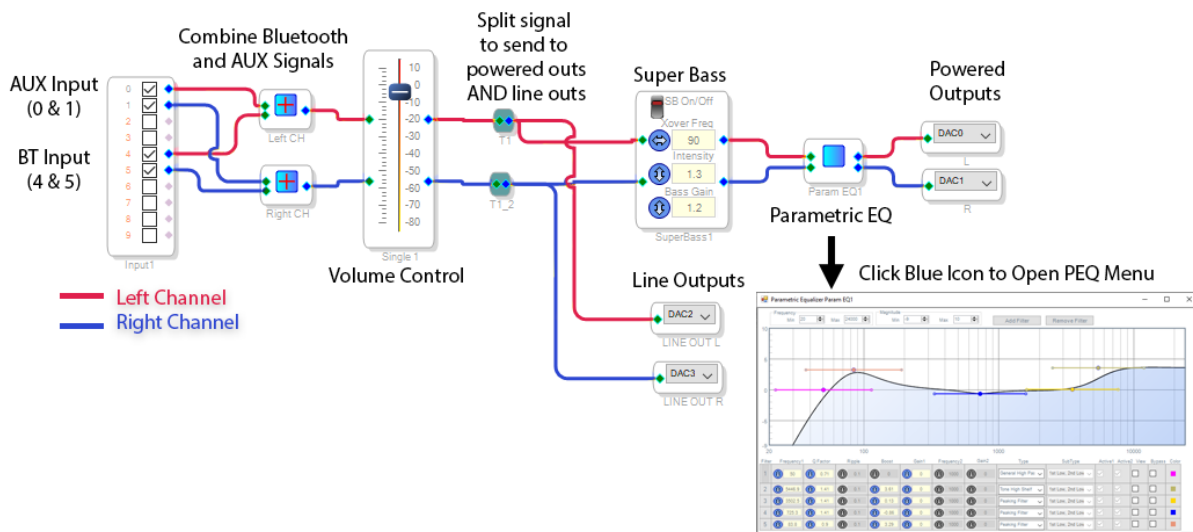

daytonaudio.com/topic/KABD

KABD-250 Specifications

Electrical Specifications

Specifications typical @ +25°C, powered by 24V DC, unless otherwise noted.

Parameter		Conditions	Min.	Typ.	Max.	Units
Number of Channels		-	-	2	-	-
Minimum Load Impedance		-	3.2	4	-	Ω
Efficiency		2 x 50W@40hm, 1kHz	-	83	-	%
Nominal Power Requirement		@24V, 1kHz	-	133	-	W
Operating Voltage		@1kHz, 40hm	12	24	26	V
Idle Power		Signal detected	-	1.8	-	W
		No Signal detected	-	105	-	mW
Switching Frequency		SD Floating@24V	-	400	-	kHz
Power Consumption		1/4 of max output power@40hm, 24V, 1kHz	-	33	-	W
		1/8 of max output power@40hm, 24V, 1kHz	-	18	-	W
Control	Standby (Low = inputs enabled)	High-level Input Voltage	3.3	-	-	V
		Low-level Input Voltage	-	-	0.8	V
	Mute (High = outputs enabled)	High-level Output Voltage	3.3	-	-	V
		Low-level Output Voltage	-	-	0.8	V
Standby Power		SD short to GND, only when low power module available	-	100	-	mW

Audio Specifications

Parameter		Conditions	Min.	Typ.	Max.	Units
Amp Gain		@40hm, 20Hz - 20kHz	-	25.8	-	dB
DSP Gain	SE1 (Single Amp)	@40hm, 1kHz	-60	-	0	dB
	SE2 (Line Output)	@40hm, 1kHz	-60	-	6.5	dB
Input Sensitivity		2 x 50W@40hm, 1kHz, 23.5dB	-	770	-	mV
Filter Gain		Butterworth, Q= 0.707	-	4	-	dB
Cutoff Frequency		HFP	0.25	-	2	kHz
		LFP	-	20	-	kHz
SNR		2 x 50W@40hm, THD+N=1%, 25.8dB, A-weighting	-	91	-	dB
THD+N		5W@40hm, 1kHz, 25.8dB	-	0.037	-	%
		10W@40hm, 1kHz, 25.8dB	-	0.039	-	%
Input Impedance		-	-	10	-	kΩ
Supported Sampling Rates		-	-	48	-	kHz
Output Noise Level		A-weighting, Input Connected to GND, 25.8dB	-	163	-	uV
DC Offset		-	-	10	-	mV
Max output Level		J7, Line Output Connector	-	1.94	-	dBu
Crosstalk Separation		20Hz-20kHz, Gain=26dB	-	-60	-	dB

KABD-230 Specifications

Electrical Specifications

Parameter		Conditions	Min.	Typ.	Max.	Units
Number of Channels		-	-	2	-	-
Minimum Load Impedance		-	3.2	8	-	Ω
Efficiency		2 x 30W@8Ohm, 1kHz	-	89	-	%
Nominal Power Requirement		@24V, 1kHz	-	67	-	W
Operating Voltage		@1kHz, 8Ohm	12	24	26	V
Idle Power		Signal detected	-	1.92	-	W
		No Signal detected	-	1.68	-	W
Switching Frequency		SD Floating@24V	-	400	-	kHz
Power Consumption		1/4 of max output power@8Ohm, 24V, 1kHz	-	17	-	W
		1/8 of max output power@8Ohm, 24V, 1kHz	-	9	-	W
Control	Standby (Low = inputs enabled)	High-level Input Voltage	3.3	-	-	V
		Low-level Input Voltage	-	-	0.8	V
	Mute (High = outputs enabled)	High-level Output Voltage	3.3	-	-	V
		Low-level Output Voltage	-	-	0.8	V
Standby Power		SD short to GND, only when low power module available	-	240	-	mW

Audio Specifications

Parameter		Conditions	Min.	Typ.	Max.	Units
Amp Gain		@8Ohm, 20Hz - 20kHz	-	26	-	dB
DSP Gain	SE1 (Single Amp)	@8Ohm, 1kHz	-60	-	0	dB
	SE2 (Line Output)	@8Ohm, 1kHz	-60	-	6.5	dB
Input Sensitivity		2 x 30W@8Ohm, 1kHz, 23.5dB	-	770	-	mV
Filter Gain		Butterworth, Q= 0.707	-	4	-	dB
Cutoff Frequency		HFP	0.25	-	2	kHz
		LFP	-	20	-	kHz
SNR		2 x 30W@8Ohm, THD+N=1%, 25.8dB, A-weighting	-	96	-	dB
THD+N		5W@8Ohm, 1kHz, 25.8dB	-	0.06	-	%
		10W@8Ohm, 1kHz, 25.8dB	-	0.08	-	%
Input Impedance		-	-	10	-	k Ω
Supported Sampling Rates		-	-	48	-	kHz
Output Noise Level		A-weighting, Input Connected to GND, 25.8dB	-	182	-	μ V
DC Offset		-	-	10	-	mV
Max output Level		J7, Line Output Connector	-	1.94	-	dBu
Crosstalk Separation		20Hz-20kHz, Gain=26dB	-	-60	-	dB