

# 8-SOURCE 8-ZONE DISTRIBUTED AUDIO MATRIX AMPLIFIER

Model: DAX88 User Manual



# DAX88 User Manual

---

For the most up to date version of the DAX88 Manual and additional DAX88 information, see the following webpage or click the user manual link in the Dayton Audio Matrio™ Mobile app. - [www.daytonaudio.com/topic/DAX88manual](http://www.daytonaudio.com/topic/DAX88manual)

## Table of Contents

- Safety.....3
- Overview .....6
- Installation.....14
  - Multiple Units .....15
  - Speakers .....16
  - Preamp Outputs .....19
  - Audio Sources.....20
  - Keypads .....22
  - Network Connection .....24
  - 12V Triggers .....28
  - Recommendations .....29
- Matrio™ - Mobile App Control.....30
  - Multiple Device Support .....31
  - Zone Control.....32
  - Group Control .....33
  - Device Setup .....34
- Wi-Fi Streaming .....35
- Factory Reset.....38
- DAX88 Specifications .....40
- RS232 Serial Control.....41
- Troubleshooting .....44

# Safety

---



**WARNING!** TO REDUCE THE RISK OF FIRE OR ELECTRIC SHOCK, DO NOT EXPOSE THIS APPLIANCE TO RAIN OR MOISTURE.

**CAUTION!** TO REDUCE THE RISK OF SHOCK, DO NOT REMOVE THE COVER, NO USER SERVICABLE PARTS INSIDE. REFER SERVICE TO A DAYTON AUDIO AUTHORIZED DEALER.

## IMPORTANT SAFETY INSTRUCTIONS

- Read and keep these instructions.
- Heed all warnings and follow all instructions contained within this manual.
- Do not use this unit near water.
- Clean only with dry cloth.
- Do not block any ventilation openings. Install in accordance with the manufacturer's instructions.
- Do not install near any heat sources such as radiators, heat registers, stoves, or other apparatus (including amplifiers) that produce heat.
- Do not defeat the safety purpose of the polarized or grounding-type plug. A polarized plug has two blades with one wider than the other. A grounding type plug has two blades and a third grounding prong. The wide blade or the third prong are provided for your safety. If the provided plug does not fit into your outlet, consult an electrician for replacement of the obsolete outlet.
- Protect the power cord from being walked on or pinched particularly at plugs, convenience receptacles, and the point where they exit from the unit.
- Only use attachments/accessories specified by the manufacturer.
- Unplug this unit during lightning storms or when unused for long periods of time.
- Refer all servicing to qualified service personnel. Servicing is required when the unit has been damaged in any way, such as when the power-supply cord or plug is damaged, liquid has been spilled, or objects have fallen into the unit, the unit has been exposed to rain or moisture, does not operate normally, or has been dropped.
- Operate the unit only with the voltage specified on the rear. Fire and/or electric shock may result if a higher voltage is used.
- Do not modify, kink, or cut the power cord. Do not place the power cord in close proximity to heaters and do not place heavy objects on the power cord and/or the unit itself, doing so may result in fire or electrical shock.
- Do not touch the speaker terminals as electric shock may result.
- Ensure that the safety ground terminal is connected to a proper ground. Never connect the ground to a gas pipe, as a severe explosion and/or fire may result.
- Be sure the installation of this product is stable, avoid unlevel surfaces as the product may fall and cause injury, property damage, electrocution and/or fire.
- Note that when the unit is turned off, it is not completely disconnected from the AC power outlet. Do not open the cover.

REFER ALL SERVICE TO A QUALIFIED SERVICE TECHNICIAN

# Sécurité

---



**ATTENTION !** POUR RÉDUIRE LE RISQUE D'INCENDIE OU DE CHOC ÉLECTRIQUE, N'EXPOSEZ PAS CET APPAREIL À LA PLUIE OU À L'HUMIDITÉ.

**ATTENTION !** POUR RÉDUIRE LE RISQUE DE CHOC ÉLECTRIQUE, NE RETIREZ PAS LE COUVERCLE, AUCUNE PIÈCE RÉPARABLE PAR L'UTILISATEUR NE SE TROUVE À L'INTÉRIEUR. ADRESSEZ-VOUS À UN REVENDEUR AGRÉÉ DAYTON AUDIO.

## CONSIGNES DE SÉCURITÉ IMPORTANTES

- Lisez et conservez ces instructions.
- Tenez compte de tous les avertissements et suivez toutes les instructions contenues dans ce manuel.
- N'utilisez pas cet appareil à proximité de l'eau.
- Nettoyez-le uniquement avec un chiffon sec.
- N'obstruez pas les ouvertures de ventilation. Installez l'appareil conformément aux instructions du fabricant.
- Ne l'installez pas à proximité de sources de chaleur telles que radiateurs, bouches de chaleur, poêles ou autres appareils (y compris les amplificateurs) qui produisent de la chaleur.
- Ne pas contrecarrer l'objectif de sécurité de la fiche polarisée ou de la fiche de terre. Une fiche polarisée possède deux lames dont l'une est plus large que l'autre. Une prise de terre a deux lames et une troisième broche de mise à la terre. La lame large ou la troisième broche sont prévues pour votre sécurité. Si la fiche fournie ne s'adapte pas à votre prise de courant, consultez un électricien pour remplacer la prise obsolète.
- Protégez le cordon d'alimentation pour éviter qu'on marche dessus ou qu'il soit pincé, en particulier au niveau des fiches, des prises de courant et du point de sortie de l'appareil.
- N'utilisez que les accessoires spécifiés par le fabricant.
- Débranchez cet appareil pendant les orages ou lorsqu'il n'est pas utilisé pendant de longues périodes.
- Confiez toutes les opérations d'entretien à un personnel qualifié. L'entretien est nécessaire lorsque l'appareil a été endommagé de quelque manière que ce soit, par exemple lorsque le cordon d'alimentation ou la fiche est endommagé, qu'un liquide a été renversé ou que des objets sont tombés dans l'appareil, que l'appareil a été exposé à la pluie ou à l'humidité, qu'il ne fonctionne pas normalement ou qu'il est tombé.
- Ne faites fonctionner l'appareil qu'avec la tension indiquée à l'arrière. L'utilisation d'une tension plus élevée peut entraîner un incendie et/ou un choc électrique.
- Ne modifiez pas, ne pliez pas et ne coupez pas le cordon d'alimentation. Ne placez pas le cordon d'alimentation à proximité des appareils de chauffage et ne posez pas d'objets lourds sur le cordon d'alimentation et/ou sur l'appareil lui-même, car cela pourrait provoquer un incendie ou une électrocution.
- Ne touchez pas les bornes des haut-parleurs, car vous risqueriez de recevoir un choc électrique.
- Assurez-vous que la borne de terre de sécurité est connectée à une terre appropriée. Ne connectez jamais la terre à une conduite de gaz, car cela pourrait provoquer une explosion et/ou un incendie.
- Assurez-vous que l'installation de ce produit est stable, évitez les surfaces non planes car le produit peut tomber et causer des blessures, des dommages matériels, une électrocution et/ou un incendie.
- Notez que lorsque l'appareil est éteint, il n'est pas complètement déconnecté de la prise d'alimentation CA. N'ouvrez pas le couvercle.

CONFIER TOUTE INTERVENTION À UN TECHNICIEN DE SERVICE QUALIFIÉ

# FCC Statement

---



## FCC Statement

1. This device complies with Part 15 of the FCC Rules. Operation is subject to the following two conditions:
  - (a) This device may not cause harmful interference.
  - (b) This device must accept any interference received, including interference that may cause undesired operation.
2. FCC Radiation Exposure Statement: Mobile device.

This equipment complies with FCC radiation exposure limits set forth for an uncontrolled environment. In order to avoid the possibility of exceeding the FCC radio frequency exposure limits, human proximity to the antenna shall not be less than 20cm (8 inches) during normal operation.

Changes or modifications not expressly approved by the party responsible for compliance could void the user's authority to operate the equipment.

**NOTE:** This equipment has been tested and found to comply with the limits for a Class B digital device, pursuant to Part 15 of the FCC Rules. These limits are designed to provide reasonable protection against harmful interference in a residential installation.

This equipment generates uses and can radiate radio frequency energy and, if not installed and used in accordance with the instructions, may cause harmful interference to radio communications. However, there is no guarantee that interference will not occur in a particular installation. If this equipment does cause harmful interference to radio or television reception, which can be determined by turning the equipment off and on, the user is encouraged to try to correct the interference by one or more of the following measures:

- Reorient or relocate the receiving antenna.
- Increase the separation between the equipment and receiver.
- Connect the equipment into an outlet on a circuit different from that to which the receiver is connected.
- Consult the dealer or an experienced radio/TV technician for help.

# Overview

---

The DAX88 8-Source 8-Zone Distributed Audio System provides ultimate audio control for six amplified zones and two line-level zones. Perfect for whole home audio systems or for business, the DAX88 is a true matrix audio system that delivers an extensive list of features for professional and residential installations. The DAX88 was designed for ease of installation by the integrator and simple operation for the end user. The DAX88 is fully controllable with the iOS and Android compatible Dayton Audio Matrio™ mobile application and is also controllable with optional wall keypads and IR remote control. The wide range of analog and digital inputs, as well as the integrated Wi-Fi / AirPlay streaming option, makes the DAX88 compatible with almost every input source. The unit will enter standby mode after two hours of inactivity to save on operational costs.

The DAX88 kit includes the following components:

- 1 x DAX88 Master Controller/Amplifier
- 1 x Rack Mounting Kit
- 1 x Installation Guide/Operation Manual
- 6 x Phoenix Connector Plugs for Speaker Connection

The following optional accessories are available and can be purchased separately.

- DAX88KP – Wall Mountable Keypads that will allow control of all basic functions for each zone, such as volume, source selection, and bass/treble adjustment.
- DAX88HUB – Rack Mountable Keypad Hub to connect all keypads to the DAX88 via a single cable.
- DAX88IR – IR Remote Control for operating DAX88 Keypad functions.

# Overview

## Dayton Audio Matrio™ Mobile App



The Dayton Audio Matrio™ app allows for complete control of any and all of the DAX88 units on your network. The Zone Control menu allows for individual control over each zone of your system. The Group Control menu is an advanced feature that lets you send commands to many or all zones at once, even zones on separate units. The settings menu has controls for custom naming your inputs, zones, and even the device name itself.

For more detailed information about Dayton Audio Matrio™ for DAX88 mobile control, see the dedicated Matrio™ section of this guide and also download the free app from the iOS or Android app store. The app can be fully explored in demo mode without a DAX88 unit.



# Overview

---

## DAX88 Front Panel

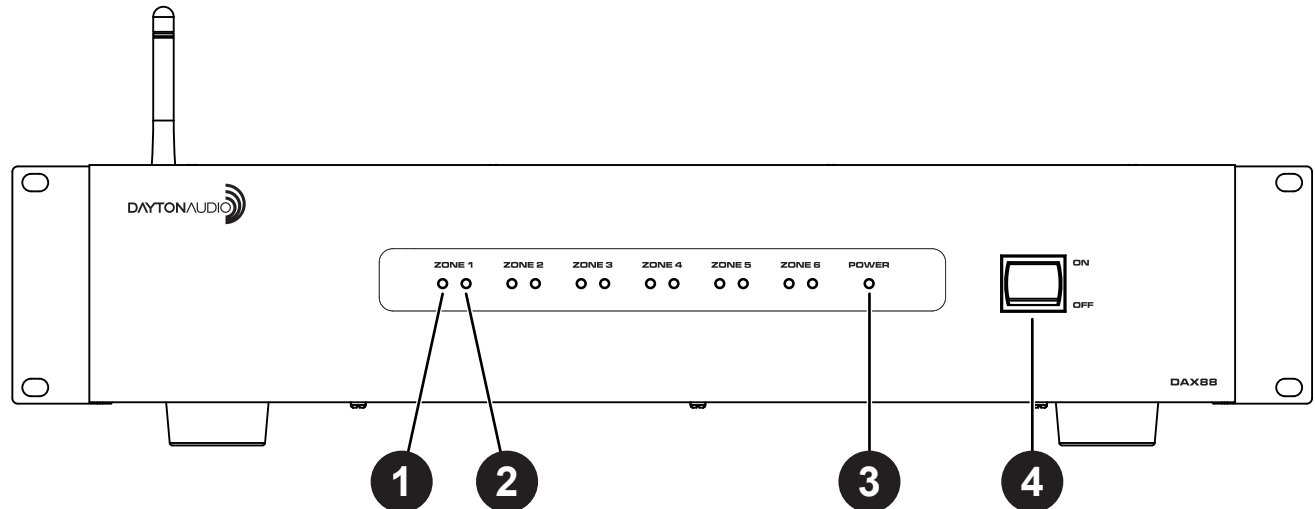

1. **Zone Signal LED** – If the input that is assigned to the corresponding zone has audio playing, the LED will be BLUE. The LED will be OFF if the input is not currently playing audio, or if the wrong input is selected for the zone.
2. **Zone Status LED** – Displays RED if the current zone is off. Displays BLUE if the zone is toggled on with the Matrio™ mobile app or a corresponding keypad.
3. **Power LED** – Indicates the power status of the DAX88. The LED displays RED if the DAX88 is connected to power and the power switch is ON, otherwise the LED is OFF.
4. **Power ON/OFF** – Toggles the DAX88 ON and OFF.



# Overview

## DAX88 Rear Panel

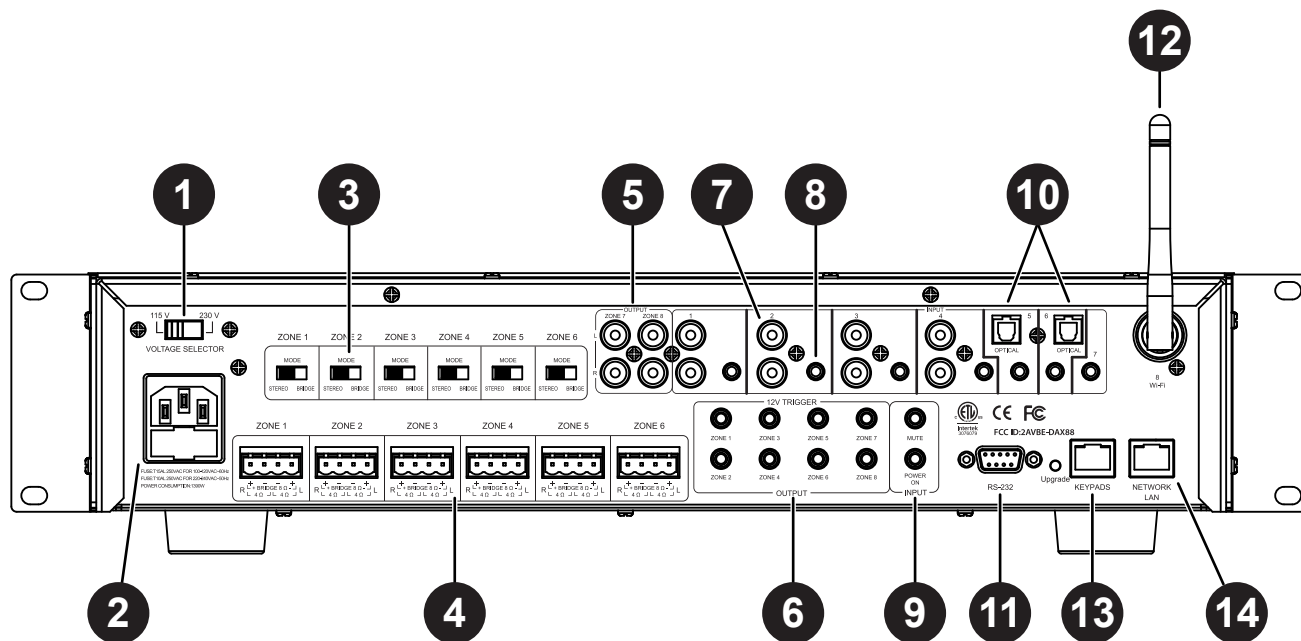

- 1. Voltage Selection** – The unit is set at the factory for 115V operation. For 230V operation, move the voltage selector switch to the 230V position. When operating at 230V the internal fuse located in the IEC socket should also be changed. In most 230V applications a separate power cord will be required and is not included.
- 2. AC Input** – The unit comes with an IEC jack that permits removal of the AC power cord. This allows the flexibility of changing the power cord for different countries. The IEC socket also houses the main fuse holder. Plug the power cord supplied with the amplifier into the amplifier and wall outlet or appropriate surge protector.
- 3. Mode Switch: Bridge / Stereo** - By changing this switch to bridge mode, the left and right channel for a zone will be combined into a single mono channel to thereby increasing the total power output for that zone. This is helpful when extra power is needed in certain areas. The minimum impedance for bridged channels is 8 ohms. Also, please observe the proper speaker wiring when bridging channels.
- 4. Speaker Output Connections** – Zones 1 - 6 on the DAX88 are stereo, powered speaker outputs for directly powering speakers. The DAX88 uses Phoenix Type Connectors (5 mm pitch) for the speaker connections. The minimum impedance for stereo channels is 4 ohms.

# Overview

---

## DAX88 Rear Panel

5. **Zone 7 & 8 Preamp Outputs** – Zone 7 and 8 on the DAX88 are Preamp outputs and represented on the back of the DAX88 as stereo RCA jacks. These zones are useful if you wish to add Matrio™ and / or keypad control to an external amplifier.
6. **12VDC Trigger Outputs** - Useful for automation systems, each zone has a corresponding 12V trigger that will output 12V when the zone is on, and 0V when the zone is off. This can be used to trigger other equipment like video screens and window blinds in the zone to turn on or off automatically along with the zone.
7. **Stereo RCA Inputs** – Inputs 1 - 4 have stereo RCA jacks for connecting any analog input source like TV's, DVD players, CD Players, etc.
8. **Stereo 3.5mm Inputs** – Every input has a stereo 3.5mm jack for connecting analog input sources like computers, iPads, mobile phones and Bluetooth receivers.
9. **12VDC Trigger Inputs** –Applying 12V to the Mute Trigger will mute all zones, and will unmute all zones if the signal is removed. Applying 12V to the Power On Trigger will turn on all zones. The zones will remain on if the 12V signal is removed.
10. **Channels 5 & 6 Digital Optical TOSLINK Inputs** – The TOSLINK inputs are useful to attach input devices to the DAX88 that are able to output a digital signal through optical TOSLINK, such as a TV or digital audio receiver.
11. **Serial Port for RS232 Control and Device Updates** – This port allows RS232 commands to be sent to and from the DAX88, which can be useful for automation systems. This port can also be used to upgrade the firmware on the DAX88. See page 41 for a list of control commands and command structure..
12. **Wi-Fi Antenna** – Allows the DAX88 to connect to your network through a wireless connection. Wi-Fi connection should only be used if a hardwired ethernet connection is not possible and if only a single DAX88 is to be installed on the network. If multiple DAX88 units are to be installed on a single network, you must use a hardwired connection to your network for each DAX88.
13. **Keypads Connection** – This RJ45 jack allows the DAX88HUB Keypad Hub to be connected to the DAX88 via a standard ethernet patch cable.
14. **Network LAN Connection** – This RJ45 jack allows the DAX88 to be connected to your network via a standard ethernet patch cable.

# Overview

---

## DAX88HUB- Keypad Hub (Optional)

The DAX88HUB Keypad Hub allows up to eight keypads, one per zone, to be hooked up to your DAX88. The keypad hub connects to the DAX88 unit through a single ethernet patch cable.

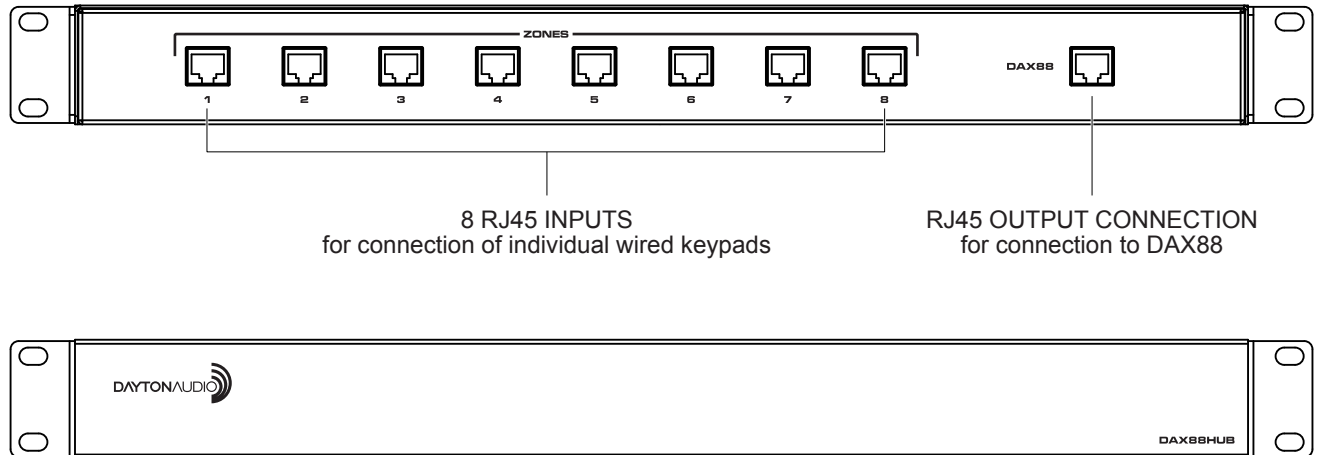

# Overview

---

## DAX88IR–IR Remote for Keypads (Optional)

The DAX88IR Infrared Remote Control provides complete zone control through the built-in IR receiver on the DAX88 keypads. All keypad functions can be accessed using the DAX88IR. In addition to the keypad functions, the DAX88IR has a mute button to temporarily mute audio in the corresponding zone. Once the mute function is activated, the keypad's LED display will flash, indicating the mute status is active. To deactivate mute, press the mute button again on the DAX88IR Remote, or disable mute with the Matrio™ mobile app.

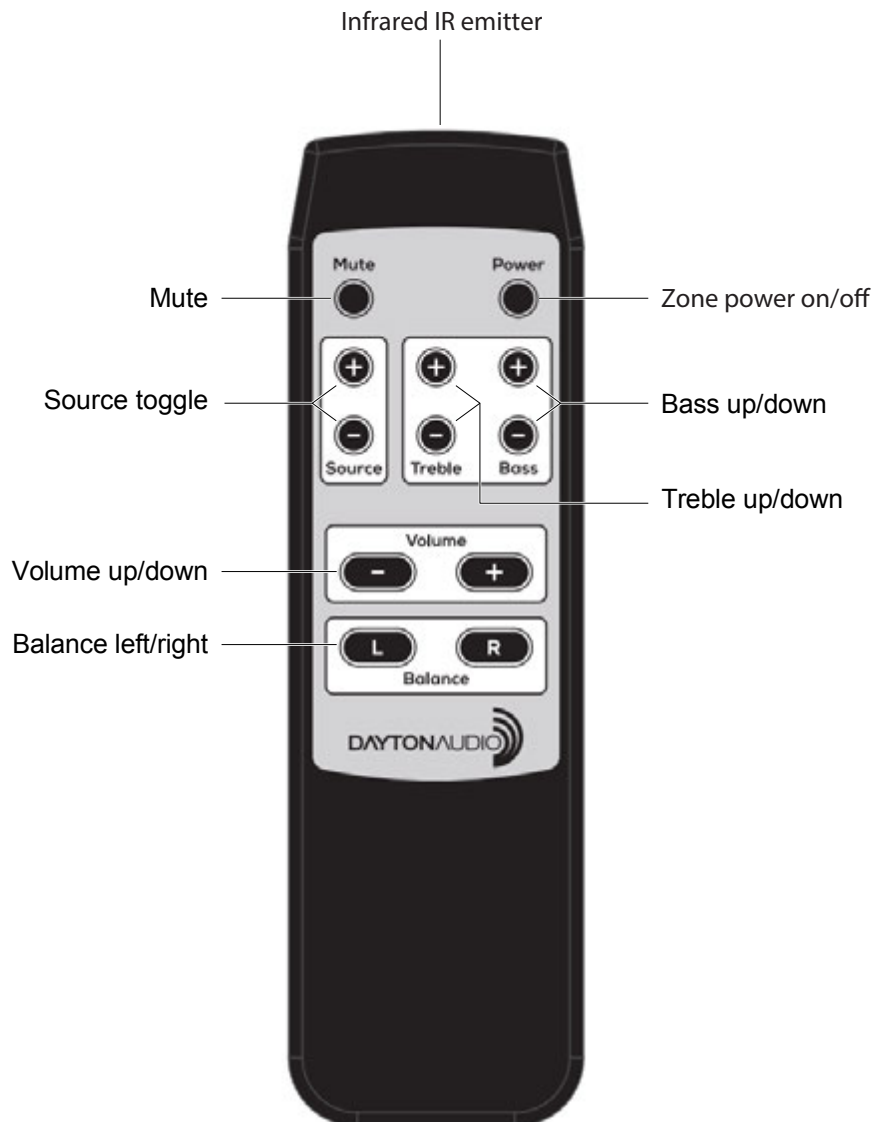

# Overview

## DAX88KP – Keypad (Optional)

The DAX88KP Keypad is designed for ease of use, providing always accessible control over the corresponding DAX88 zone. Soft-touch backlit buttons and a backlit LED display provide convenient control of the zone with the following options; ON/OFF, source 1 - 8 selection, volume, treble adjustment, and bass adjustment. The built-in IR target or an external IR target connected to the EXT-IR terminals on the rear of the keypad can relay commands to the DAX88 main unit by using a DAX88IR IR Remote. Each DAX88KP will control only one zone at a time. The zone number is assigned with configurable with dip switches on the back of the keypad.

Five LEDs on the keypad face indicate the operational function of the keypad. The EXT LED indicates that the system is receiving a trigger command from an external IR target.

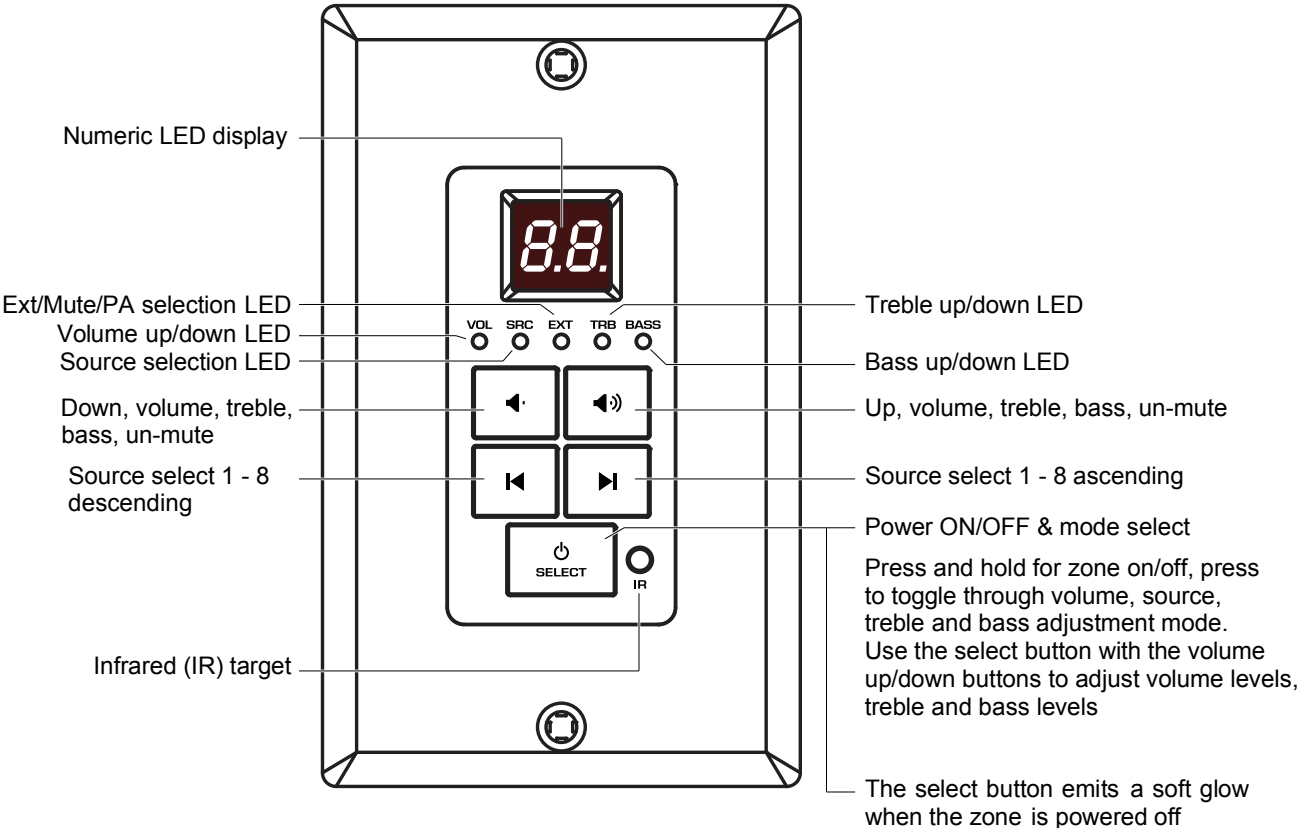

# Installation – DAX88

---

Install the DAX88 in a well-ventilated location; do not block the vents on the sides or top of the chassis, proper ventilation is required for normal operation. Do not expose the unit to excessive dust, do not allow dust to build up on the unit, and do not block the vent holes in the chassis. Do not place the DAX88 above or below heat-generating components such as another audio amplifier. Be sure to leave at least two inches of space to the sides of the chassis with open air flow above and below the unit. Due to the weight of the unit, use four post racks at a minimum when installing into a standard A/V equipment rack.

## Overview

1. The DAX88 and DAX88HUB Keypad Hub can be mounted in a standard 19" A/V equipment rack using the included rack mount kit.
2. When possible, test that all of your speakers and input devices are working properly before attaching them to your DAX88.
3. Plan on installing your DAX88 in a location where you will have wired network access. This means you can install the DAX88 near a network switch, or plan to run a Cat6 network wire from your router to the network port of your DAX88. Although it is possible to configure the DAX88 to the network using Wi-Fi, it is not recommended. More details about network configuration are found in the sections below.
  - a. Ensure that you have a robust and stable wireless network before installing your DAX88. Control of the DAX88 through the Matrio™ mobile app will not work properly without a working and reliable wireless network.
  - b. Plan to have a secure wireless network that only trusted devices will be on. With the Matrio™ app, any user on the same network as the DAX88 will be able to make changes to the system.
4. Always disconnect AC power before making connections to the DAX88.
5. Use high quality 12 or 14 AWG stranded copper speaker wire for all speaker connections.
6. The DAX88 uses an optional keypad hub to connect all of your optional keypads to the DAX88. We recommend Cat5e (or better) cabling to connect your keypad to the keypad hub, and also to connect the keypad hub to the DAX88. Since RJ45 connectors are used for all keypad connections, buying ethernet patch cables pre-terminated with RJ45 connectors might be desirable, if you do not want to terminate the wires yourself.
7. Following installation of your DAX88 unit, speakers, inputs and other accessories, the power switch on the front of your DAX88 device will need to be switched to the 'ON' position before it can be used. Make sure that the voltage switch is set correctly on the back of the unit according to your country's electrical voltage before turning it on. Plugging the amplifier into 230V power while the voltage switch is set to 115V mode WILL damage the device.
8. It is highly recommended to label all of your wires during the installation process, which will make it much easier to fully setup your device in the Matrio™ app following installation.

# Installation – DAX88

---

## Installing Multiple DAX88 Units

Due to the intelligent design of the app that controls the DAX88, Dayton Audio Matrio™, there is no limit to the amount of DAX88 devices that can be used on a single network. The app will seamlessly add any DAX88 units it can find on the network with no additional setup. The Group Control mode of the app can even control multiple zones from different DAX88 units at the same time. To use multiple DAX88 units, simply connect each of your units to the same network and the Matrio™ app will handle the rest. If you are installing multiple units onto your network, it is important to hardwire all units to your network with ethernet patch cables instead of Wi-Fi. Do not connect any of your DAX88 units to your network with Wi-Fi if you are using more than one DAX88 on a single network. More information about network connectivity can be found in the network section of this guide.

# Installation – Speakers

---

## Speakers

- Use good quality 12 or 14 AWG stranded copper speaker wire. Most jurisdictions require the use of CL2 rated in-wall speaker wire, refer to your local building code enforcement office for the proper cable type for your installation.
- If speaker wires must be run parallel to AC wires, try keep the speaker wires and AC wires at least 10 inches apart in order to avoid hum or interference. If you must cross AC wires, always cross at a 90-degree angle.
- The DAX88 amplifiers are capable of driving 4 - 8 ohm speaker loads in STEREO mode, and 8 ohm loads in BRIDGE mode.
- When possible, ensure that your speakers are working properly before attaching them to the DAX88.
- Improper speaker installation can damage the amplifiers and void the warranty. If you are unsure how to connect speakers to the DAX88, contact a qualified technician.
  - Never connect more than two 8 ohm speakers wired in parallel to a single amplifier channel in STEREO mode.
  - Never connect more than one 8 ohm speaker to a single channel in BRIDGE mode.
  - Never connect the Left & Right channels of the amplifier together or combine the (-) negative channels of the amplifier.
- Remove the terminal block connector and make sure that all contacts are open by turning each set screw counter clockwise. This helps ensure that the speaker wire will not fray when inserted into the terminal. After inserting the speaker wire into the terminal, turn each set screw clockwise until tightly connected.
  - Pay special attention to the polarity (+ and -) so the speakers are wired correctly in phase. If your left and right channel are connected 'out of phase', sound will still come out of both speakers, but in most cases, the interaction between the two speakers will cause unwanted cancellations of your audio, especially in the bass region. (Now is a good time to double check your connections to make sure the you do not have frayed speaker strands that will cause a short at the connector).



# Installation – Speakers

## Connecting speakers to the DAX88 in STEREO MODE

Set the amplifier mode switch to STEREO. Remove approximately five inches from the speaker cable jacket, strip 1/4" of insulation from the speaker wire, and twist the copper strands. Insert the speaker wires into the connector per the label below the output terminals and tighten the set screws. Repeat for the remaining zones.

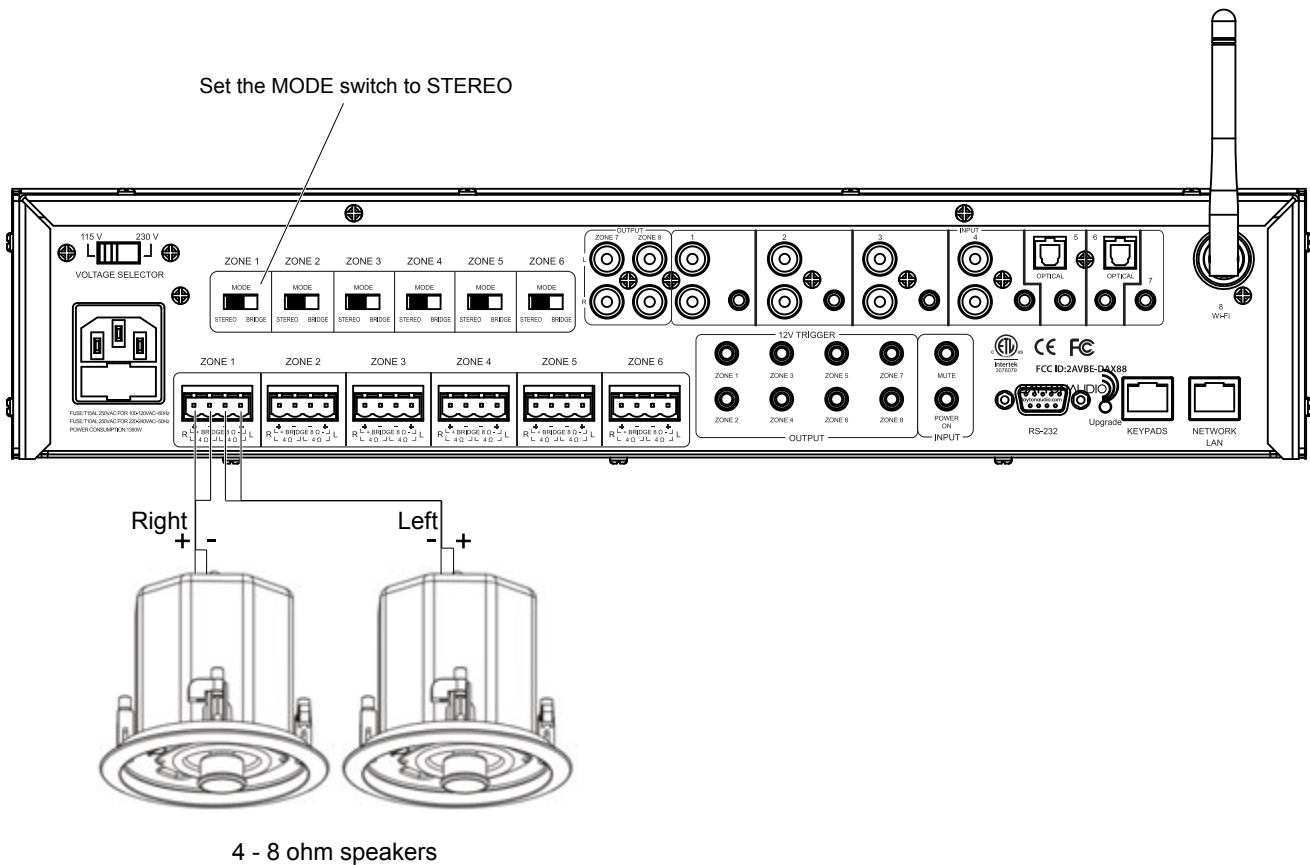

# Installation – Speakers

## Connecting speakers to the DAX88 in BRIDGE MODE

In BRIDGE mode the amplifier LEFT and RIGHT outputs are combined into a more powerful MONO output, thus doubling the output power into 8 ohms (minimum speaker load in bridge mode is 8 ohms). Remove approximately five inches from the speaker cable jacket, strip 1/4" of insulation from the speaker wire, and twist the copper strands. Insert the speaker wires into the connector per the label below the output terminals and tighten the set screws. Repeat for the remaining zones. It is permissible to mix STEREO and BRIDGED mode zone outputs on one DAX88. For example, Zone 1 – 4 could be in BRIDGED mode, while Zone 6 – 7 are in STEREO mode.

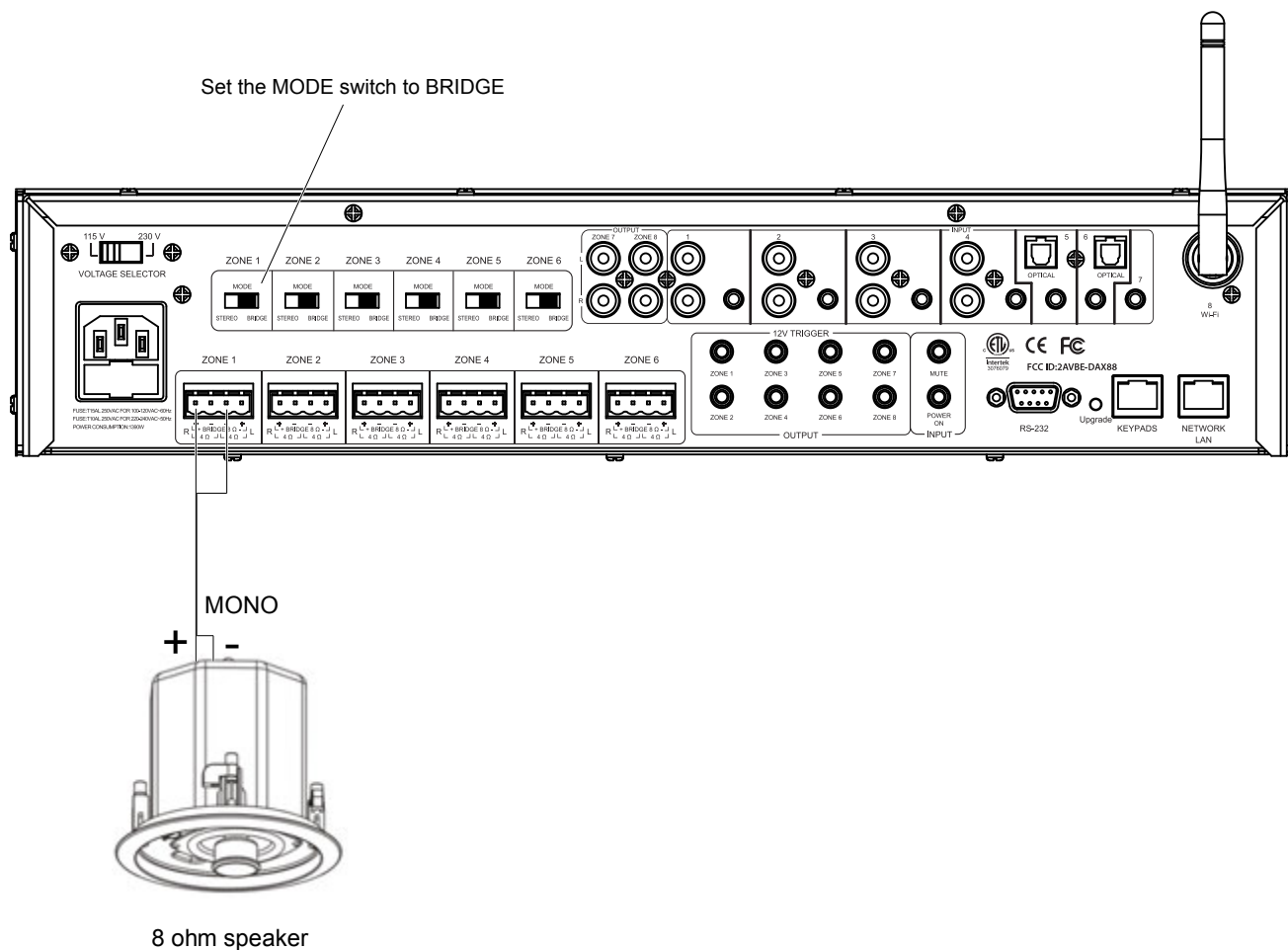

# Installation – Preamp Outputs

## Using DAX88 Preamp Outputs

Zone 7 and 8 of the DAX88 are Preamp Zones and are represented on the unit as stereo RCA jacks for each zone. These Preamp Zones can be used for connecting external amplifiers, or could even be used to add a powered subwoofer to the location of another zone. These Preamp outputs could also be used to feed an audio signal into another DAX88 unit.

The DAX88 can be used as the master controller in large commercial audio systems with constant voltage 25/70V amplifiers connected to these Preamp outputs. The Preamp output levels are variable and are controlled from the Matrio™ app, DAX88 keypad or even RS232 from an automation system. For best performance, the Preamp output cables should be less than 25 feet long and be high-quality, shielded cables.

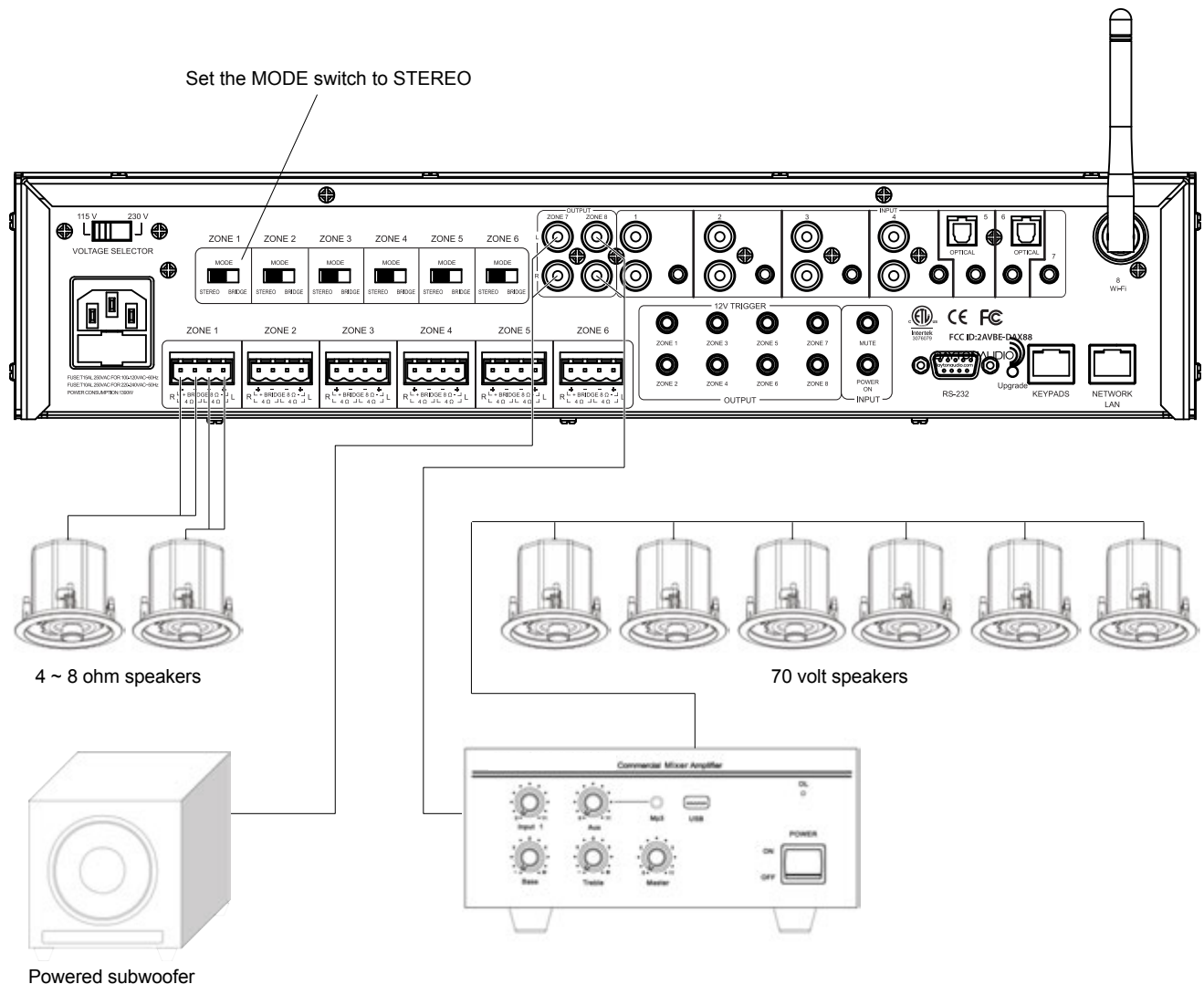

# Installation – Audio Sources

The DAX88 provides eight source inputs that can be accessed by any zone.

- Inputs 1 - 4 are stereo, unbalanced, line-level source inputs via RCA style female connectors or a female 3.5mm jack. If both inputs are present, the audio from each will mix together.
- Inputs 5 - 6 have options for TOSLINK (optical) input, or analog audio input through a 3.5mm jack.
  - If using TOSLINK, make sure to use “PCM-Stereo” or Auto Detect setting on your source device. Your device should be set to auto detect by default and work properly, but if not, you can usually find these settings in settings -> Audio -> S/PDIF or something similar. Refer to the user manual of your source device. You will know if your settings are correct or not, because if they are incorrect, the sound will be digital noise rather than proper audio. Keep the volume of any zones set to this input very low until you have verified the audio is correct and not digital noise.
  - The 3.5mm jack will take priority over the TOSLINK input, meaning that if anything is plugged into the 3.5mm jack, the TOSLINK input will be disabled. These inputs will NOT mix.
- Input 7 is a 3.5mm jack for analog, stereo audio.
- Input 8 is Wi-Fi streaming, and is represented on the back of the DAX88 with a wireless antenna. More information about wireless streaming can be found in the “Wi-Fi Streaming” section of this guide.

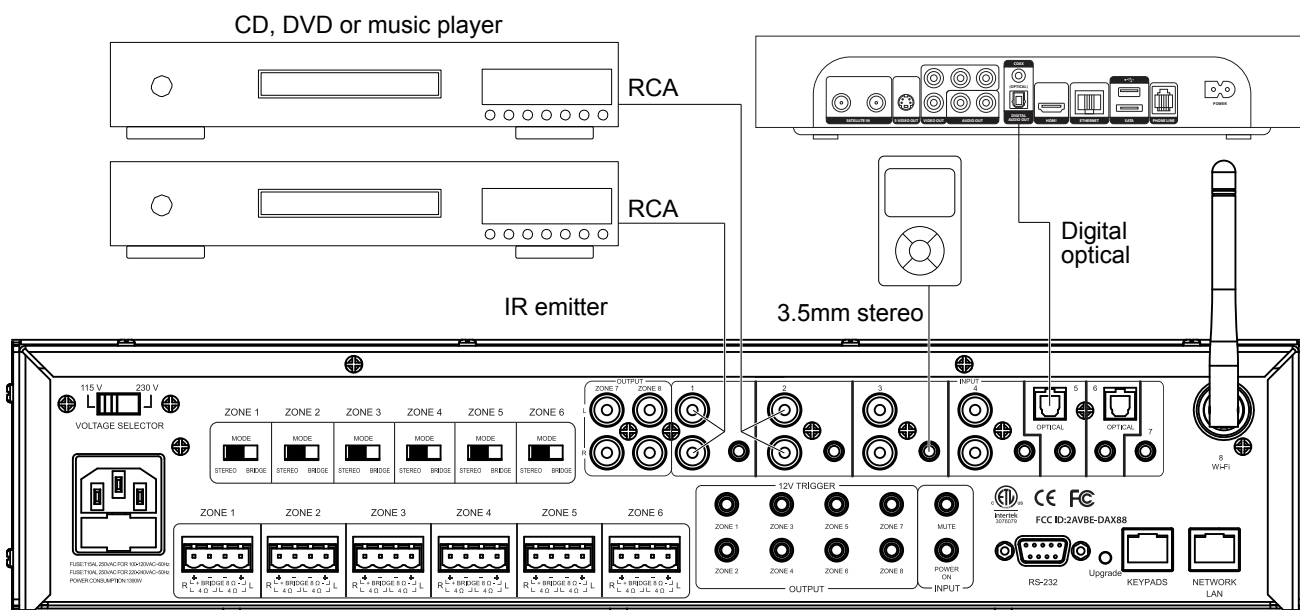

# Installation – Audio Sources

## How to Wire Inputs to Multiple Devices

If you have multiple DAX88 units and want to use the same input on both of them you have two options.

1) The preferred option is to split your input source and route it to both devices. There are many devices and cables available from your Dayton Audio retailer that will split an analog or TOSLINK signal so you can connect it to multiple DAX88 devices. You will need to name both inputs the exact same name within the Matrio™ app for each DAX88 unit to ensure that group control input switching works correctly. See the diagram below, which is an example using a CD player as an input connected to DAX88\_1 and DAX88\_2 using an aux splitter (male 3.5mm to dual female 3.5mm).

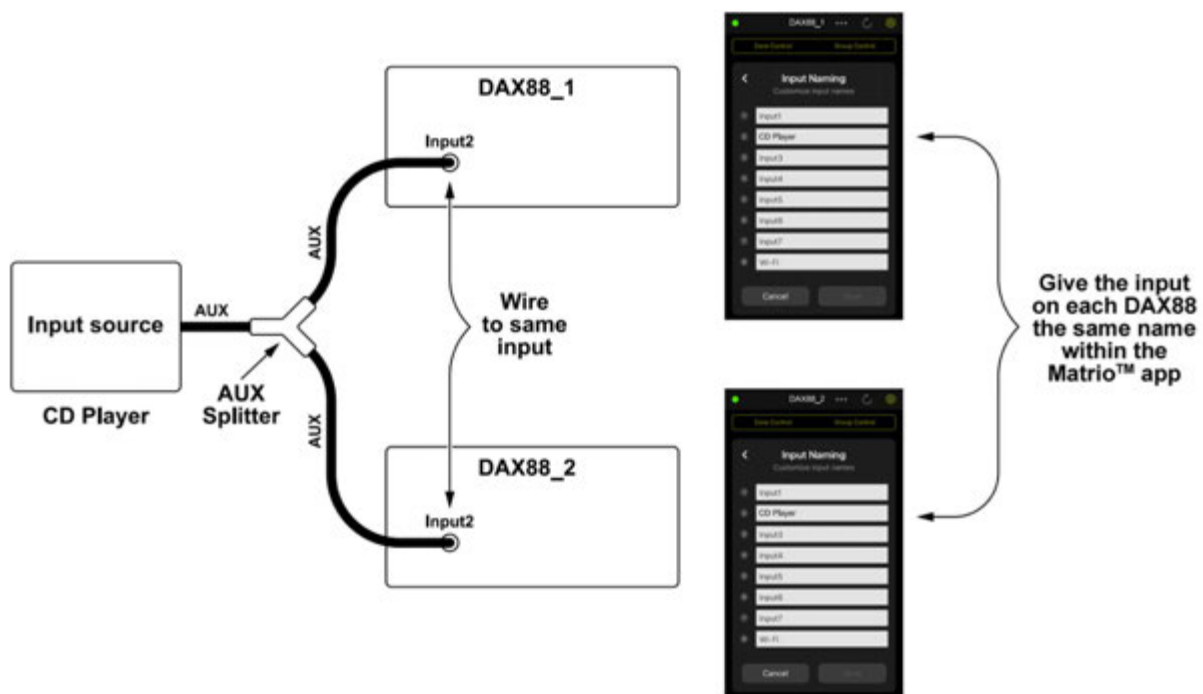

2) Because Zone 7 and 8 are Preamp outputs on the DAX88, these zones could be used to route an audio signal into your second DAX88. For example, if you are streaming music using the Wi-Fi input of your first DAX88, set either zone 7 or 8 of your first DAX88 to input 8 (Wi-Fi), and then connect zone 7 or 8 to one of the inputs on your second DAX88. This will effectively share the input between your device. (Note that you will need to have zone 7 or 8 switched on for this to work.)

# Installation – Keypads

In addition to control with the Matrio™ app, each DAX88 zone can be controlled with keypads that can be mounted into a standard single-gang wall plate. Up to eight keypads (one per zone) can be installed to the DAX88 with the help of the DAX88HUB keypad hub. Keypads offer convenient control for volume, source input, bass adjustment and treble adjustment. The keypads also feature an IR sensor that can be used with the DAX88IR Remote Control.

1) Use high quality Cat5e (or better) cable between the DAX88, DAX88HUB, and DAX88KP keypads. Proper installation techniques will guarantee that the keypads will work properly up to 600 feet from the DAX88. The use of RJ45 (typical ethernet) connectors on the keypads and keypad hub means that pre-terminated cables can be easily sourced, and the equipment to terminate the cabling yourself can be easily found, if necessary. The typical keypad installation will utilize a DAX88HUB Keypad Hub attached to the DAX88, and up to eight keypads attached to the HUB.

2) If you are crimping your own RJ45 jacks, the 'B' configuration should be used. This is the 'standard' configuration, and is how a typical ethernet patch cable you would buy from a retailer is wired.

3) A standard IR target can be attached to the back of the keypad to the green port with labels +5V, GND, and Data. This can be useful if you want to be able to point the remote a different direction than where the keypad is.

## DAX88

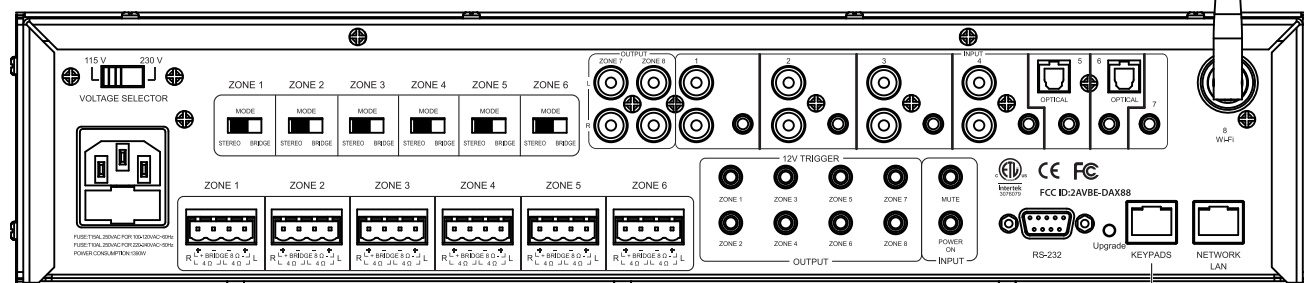

## DAX88HUB – Keypad Hub

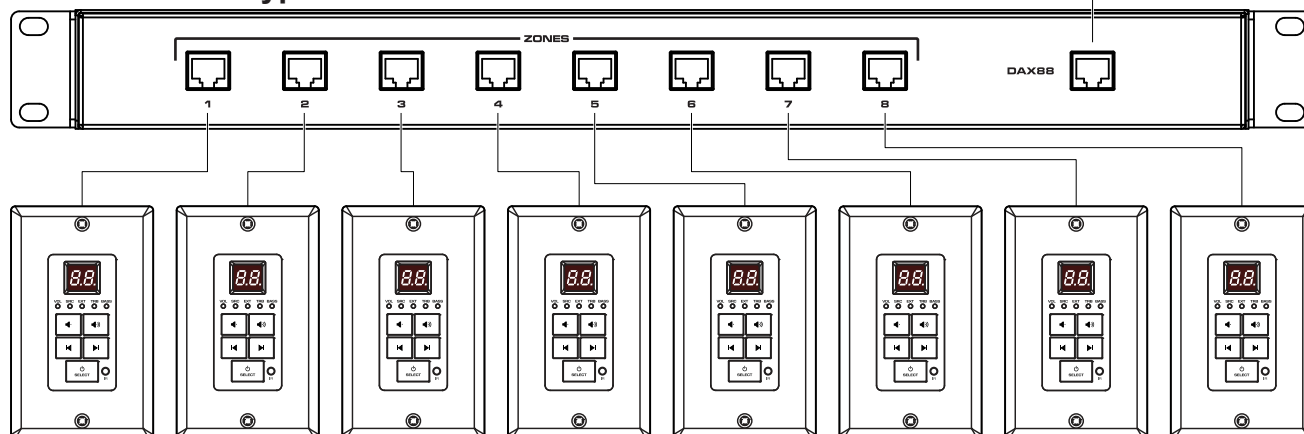

## DAX88KP – Keypad

# Installation – Keypads

---

4) Use standard electrical boxes or low voltage rings to mount the keypads. Connect the DAX88HUB to the master controller/amplifier using a standard ethernet patch cable.

5) Although the DAX88HUB is labeled with 1 – 8 for each of the eight zones, the dip switches on the back of the keypads must be set so they correspond to the correct zone like the chart below shows. Plugging the keypads into the 1 – 8 labels of the hub does NOT determine which zone each keypad controls. Setting the dip switches gives each keypad a distinct address. The up position is 'ON', whereas the down position is 'OFF'. This chart is also found on each keypad for ease of installation. The example on the right has the correct settings for "Zone 3". **IMPORTANT:** If you do not complete this step for each keypad, your keypads will not control the correct zone.

Zone	1	2	3
Zone 1	ON	ON	OFF
Zone 2	ON	OFF	ON
Zone 3	ON	OFF	OFF
Zone 4	OFF	ON	ON
Zone 5	OFF	ON	OFF
Zone 6	OFF	OFF	ON
Zone 7	OFF	OFF	OFF
Zone 8	ON	ON	ON

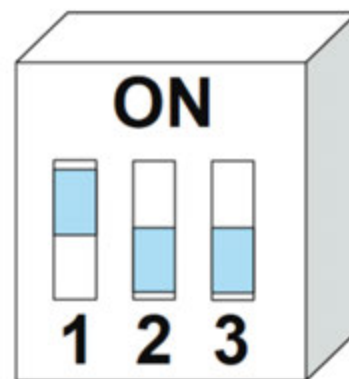

# Installation – Network Connection

## Wired Connection – (Best Practice)

The DAX88 can be connected to your network using a standard ethernet patch cable (Cat6 or better). Simply connect one end to your network router or switch, and the other end to your DAX88's network jack. Once this connection is made, your DAX88 will be ready to connect to the Matrio™ app on either Android or iOS after just a few moments. Make sure that you are connecting your DAX88 to the same exact network that your mobile devices are on.

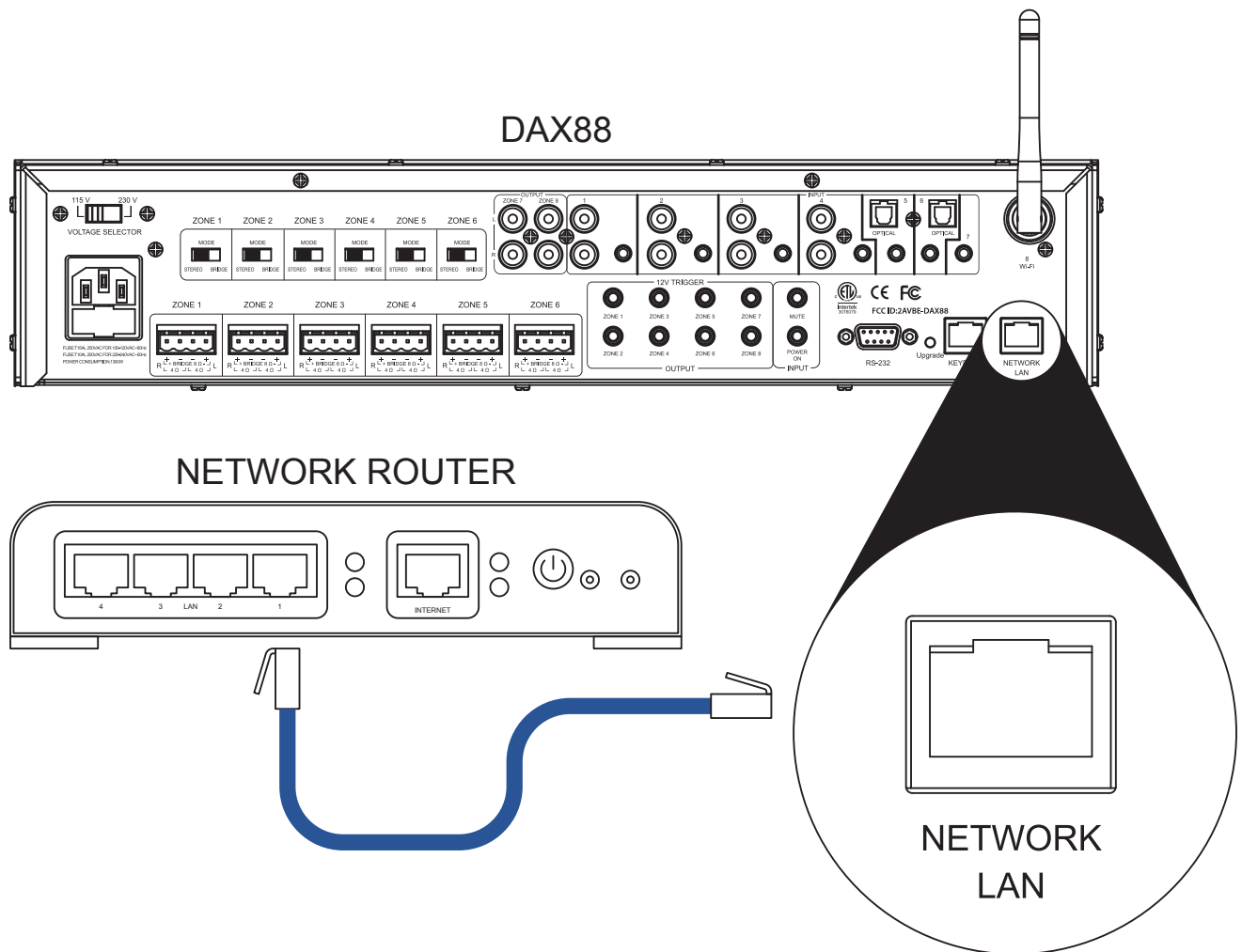



# Installation – Network Connection

**(Optional) Secure the DAX88's SSID / Internal Wi-Fi network** – When a wired connection is used to connect your DAX88 to the network, the DAX88 will continue to broadcast its own internal Wi-Fi (SSID) as an open network (no security). Much like a wireless printer, this will not cause you any issues, however it means that anyone within range of your DAX88 can connect directly to it and change your DAX88's settings, even if they are not on your network. To prevent this, you can easily secure the DAX88's network with the following steps. **Note:** These steps are likely to change with future updates to the Dayton Audio Hi-Fly app.

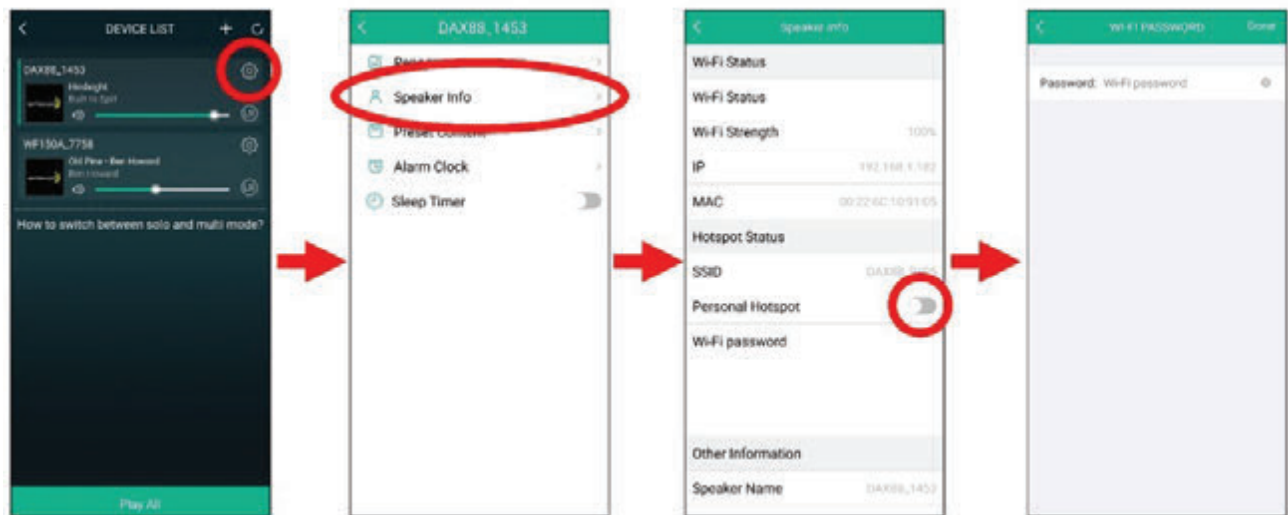

- Step 1:** Download and install the “Dayton Audio Hi-Fly” app from the app store. Open the Dayton Audio Hi-Fly application. Look for your DAX88 device and press the gear icon as circled above.
- Step 2:** Press the “Speaker Info” button in the menu.
- Step 3:** This screen is subject to have minor changes in future updates to Dayton Audio Hi-Fly. Look for the “Personal Hotspot” and enable it temporarily by pressing the button circled in red. Note: The DAX88 does not work as a hotspot, however this option allows you to secure your DAX88's internal Wi-Fi SSID. The language will be updated in a future update of the app, as such, your screen might look slightly different.
- Step 4:** After pressing the personal hotspot button from step 3, you will be directed to the final screenshot above. Enter your desired password in the box and press done. Note: If this password is ever forgotten, a factory reset can be performed using the Matrio Control app to reset this password.
- Step 5:** Your DAX88's wireless network / SSID will now be secured with your chosen password. You should now return to the screen found in screenshot 3 and turn off personal hotspot.

# Installation – Network Connection

## Wireless Connection

If a wired ethernet connection is not possible or not feasible in your DAX88 install, you can easily connect your DAX88 to your network via Wi-Fi. Although it is preferred to use a wired connection, if your installation would require running an ethernet cable to the location of the DAX88 install, you can try using Wi-Fi before running the cable. If Wi-Fi does not prove to be a stable connection, we recommend running an ethernet cable and following the WIRED guide on the previous page.

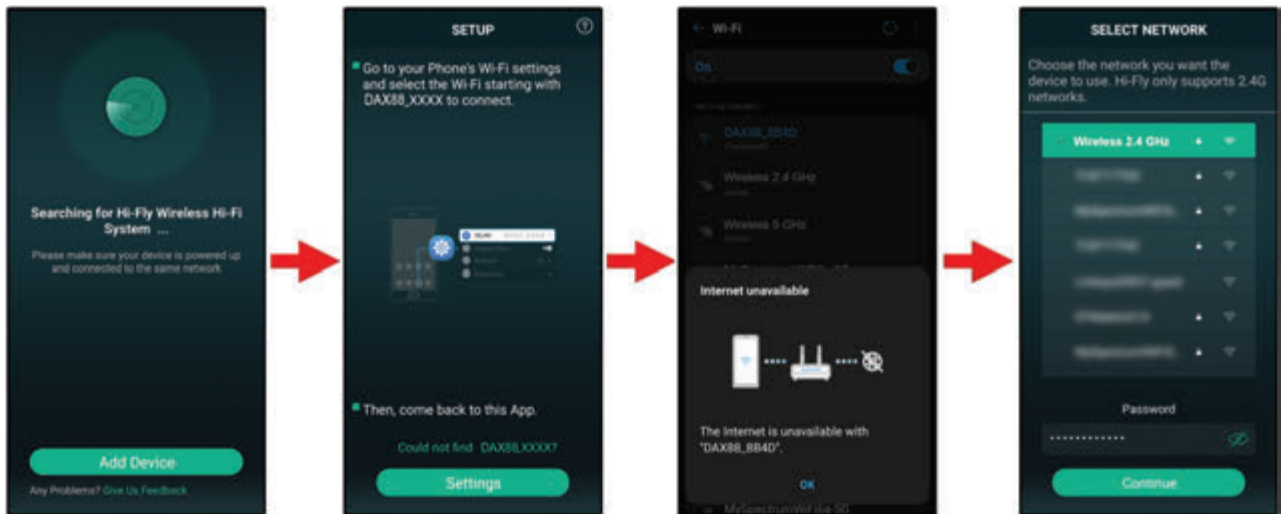

**Step 1:** Download and install the “Dayton Audio Hi-Fly” app from the app store. Open the Dayton Audio Hi-Fly application. Note: Hi-Fly can be deleted once these steps are complete, however it can also be used for streaming audio to your DAX88.



**Step 2:** Press the “Add Device” button as shown in the diagram above. If you already have a Hi-Fly device configured on your network, press the ‘+’ button in the top right corner of your screen to add the DAX88.

**Step 3:** As prompted by the app, press the provided settings button shortcut on the screen. This will take you to your phone or tablet’s Wi-Fi setup screen (this will look slightly different, depending on if you are on iOS or Android).

# Installation – Network Connection

---

- Step 4:** Within your Wi-Fi settings, you will be temporarily connecting to your DAX88's internal Wi-Fi network during setup. Find the network called "DAX88\_XXXX", where "XXXX" is a unique identifier for your specific DAX88. You will likely be prompted with a message that tells you that internet is unavailable with this network – that is expected, because the connection is only temporarily used in setup, and you will later switch back to your normal Wi-Fi network.
- Note:** If you are not seeing a DAX88 Wi-Fi network, try first moving closer to your DAX88. If that does not work, restart your DAX88 by powering it off with the switch, waiting 30 seconds, and turning it back on.
- Step 5:** Re-open the Hi-Fly app. You will now be prompted to select your Wi-Fi network and enter the password. This step is done so that the DAX88 can be connected to your Wi-Fi network, in the same way that your phone or laptop would be.
- Step 6:** Assuming all previous steps have been completed properly, you will be prompted to give your DAX88 a custom name. Skip this step for now. If you would like to customize your DAX88 name, please instead complete this step in the Dayton Audio Matrio™ Control app.
- Step 7:** Your DAX88 is now connected to your network via a wireless, Wi-Fi connection, and is available for total control in the Dayton Audio Matrio™ Control app, and also available for wireless streaming. Your phone should automatically switch back to your original Wi-Fi network ("Wireless 2.4GHz" in this case), however if it does not, enter your Wi-Fi settings menu and select your network. Always make sure your phone or tablet is connected to the same network as your DAX88!

# Installation – 12V Triggers

The DAX88 has two sets of 12V triggers for each zone on the rear of the device to automate your audio system even further. All connections should be made with a 3.5mm mono cable, and connect all signals as tip positive.

- The first set of triggers labeled “output” will output a 12V signal that corresponds to a zone being on or off. For example, if you wire a cable to the 3.5mm port for Zone 1’s trigger, you will get a 12V signal on that wire when the zone is on, and 0V when the zone is off. This 12V signal can be useful for turning on other equipment automatically like a projection screen, lights, or an external amplifier.
- The second set of triggers contain two different functions.
  - The mute trigger will mute all zones if it receives a 12V signal, but it will unmute once the 12V signal is removed. This trigger will take precedence over any mute settings you make in the Dayton Audio Matrio™ app, keypad, or with the IR remote.
  - The power on trigger will turn on all zones if it receives a 12V signal. Zones will stay on even after the signal is removed. For example, if a 12V signal is applied to the power on trigger, all zones will turn on. When the 12V signal is removed, the zones will stay on until standby or they are manually turned off.

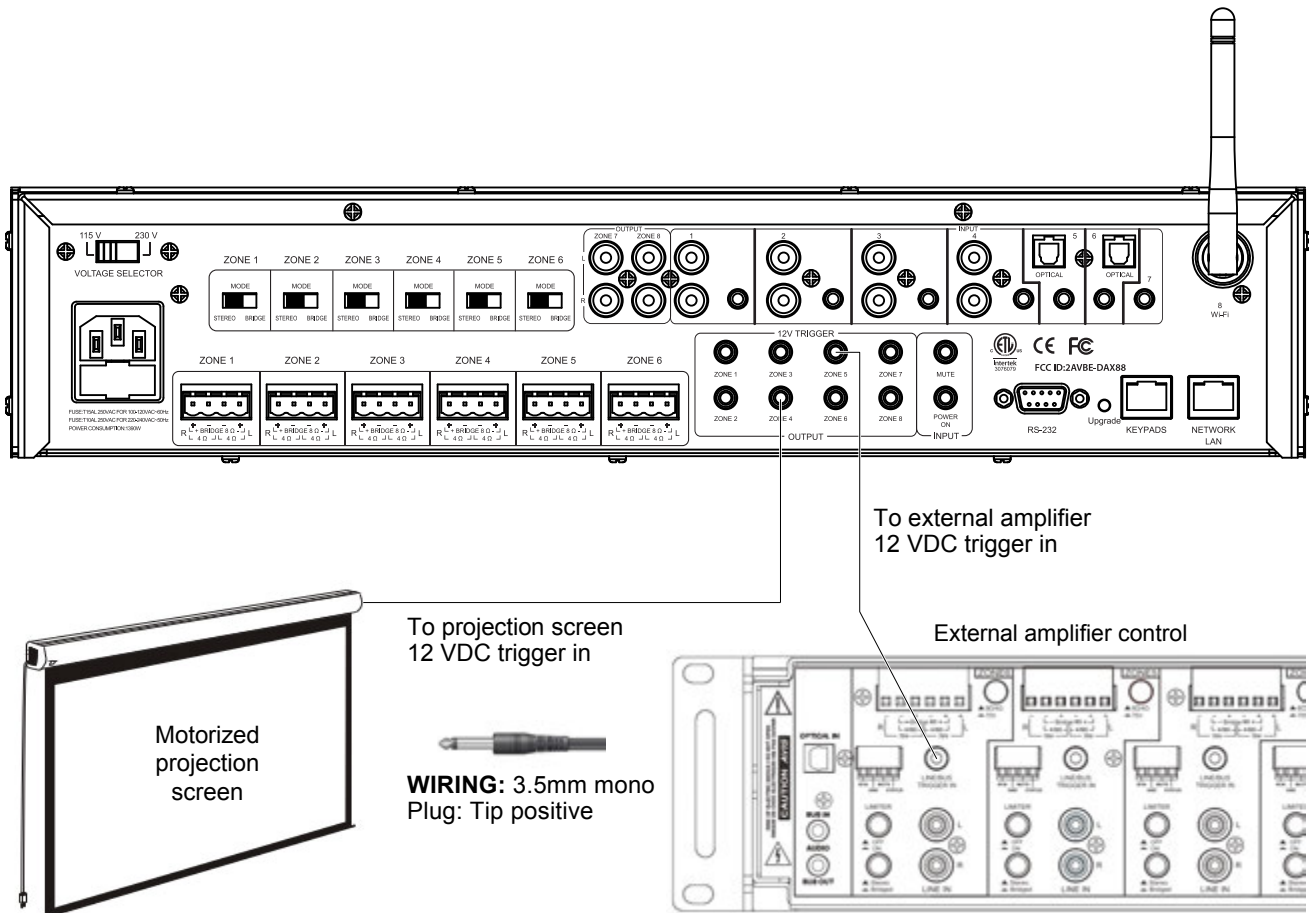

# Installation – Recommendations

---

- 1) Consider dedicating a mounted tablet to always run the Matrio™ app for control of your DAX88 device. This could be especially useful in a business setting, or for allowing users not connected to your wireless network to control the audio.
- 2) Name all of your zones and inputs using the Matrio™ app immediately after installation so the DAX88 system is easy to use for those who did not do the installation.
- 3) Give your DAX88 a suitable custom name, especially if you are installing multiple units onto a single network.
- 4) Label all cables.
- 5) Double check all of your connections after installation and before use. Pay particular attention to the polarity of your speaker connections and ensure that you do not have frayed speaker wire strands that can cause a short at the connector.
- 6) Adjust treble and bass to your liking for each zone. However, ensure that your speakers will be able to handle any bass boost you might do at higher volumes.
- 7) Because Zones 7 and 8 are line level (RCA outputs), they can be used to attach your DAX88 to an existing audio system to allow it to be controlled with the Matrio™ app. For example, if you have an existing 70V system with speakers already wired, you could simply attach the Zone 7 or 8 RCA output from your DAX88 to the input of your 70V amplifier. This will allow you to have some additional control over your existing system with the Matrio™ app or a keypad that you would not have had previously. Additionally, if the amplifier has the ability to accept a 12V trigger to be turned on, you can use the Zone 7 or 8 output trigger to turn on this amplifier when the zone is turned on.

# Matrio™ - Mobile App Control

The Dayton Audio Matrio™ app features convenient mobile control over all of the functions of the Dayton Audio DAX88. The app offers two main screens for control and also a settings menu that offers extra customization. Matrio™ can be found by searching “Matrio” on the iOS or Android app stores.



## Demo Mode

The Dayton Audio Matrio™ app has a built in ‘Demo Mode’ that allows you to explore functions of the app without having a DAX88 unit on the current network. The app will say “DAX88 Demo” and function as it would if you had an actual DAX88 unit on the network. This mode can be launched if the device is not connected to Wi-Fi, or if the Matrio™ app does not find a DAX88 on the current Wi-Fi network.

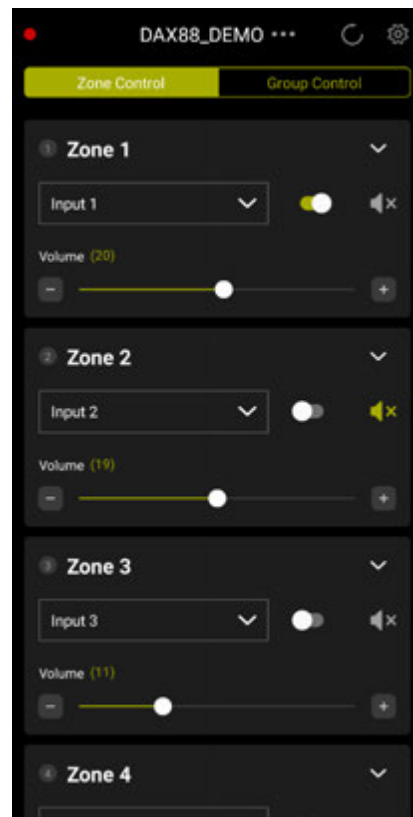
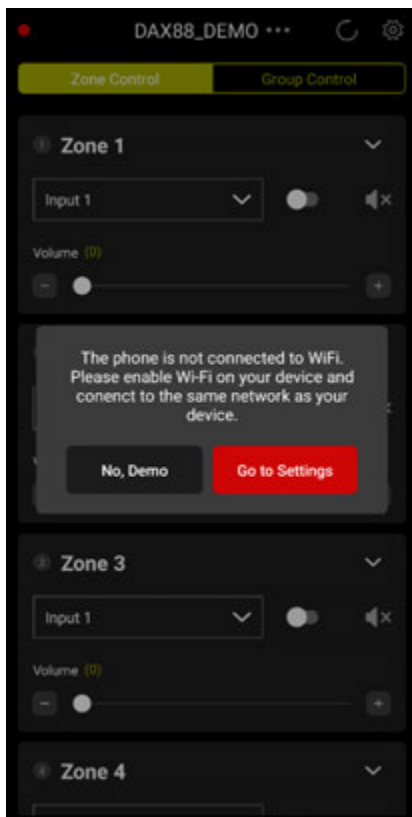

# Matrio™ - Mobile App Control

## Multiple Device Support

Matrio™ will automatically connect to all DAX88 devices that it finds on your current wireless network. To see a list of all of the currently connected devices, and to switch between them, press the name of the current DAX88 or the three dots next to it as shown below. Selecting the correct device is necessary while in the zone control and settings menus. If you only have one DAX88 unit, you will not need to use this menu.

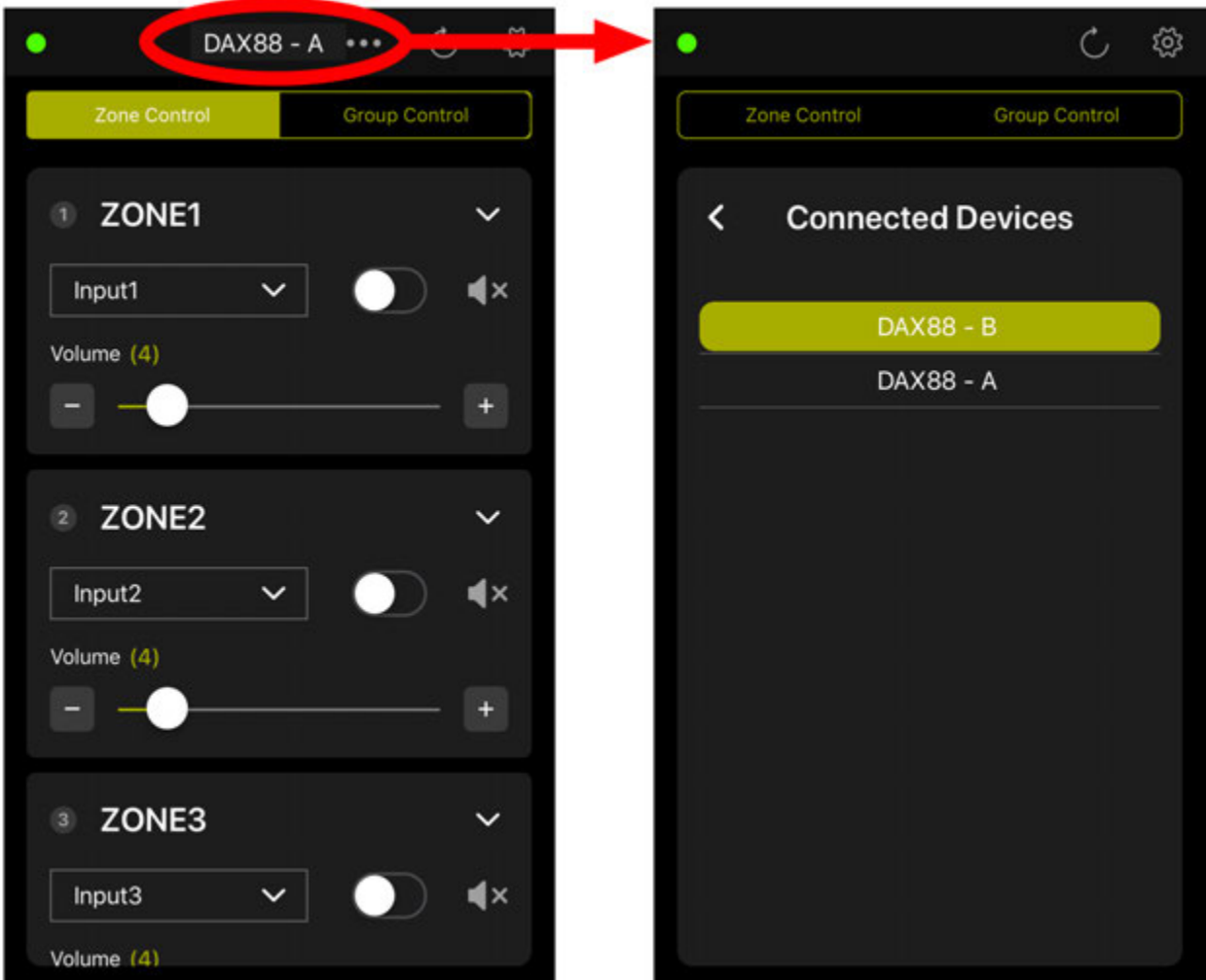



# Matrio™ - Mobile App Control

## Zone Control

The Zone Control menu offers control over all possible settings for each particular zone of your DAX88. All zones of the currently selected DAX88 device will be found in a scrollable list. The settings include - power on/off, input selection, volume control, mute on/off. Additional settings such as balance, bass and treble control can be found by expanding each zone's control card with the arrow button. All custom zone names and input names will appear in this menu, allowing for easier control once the device is fully setup.

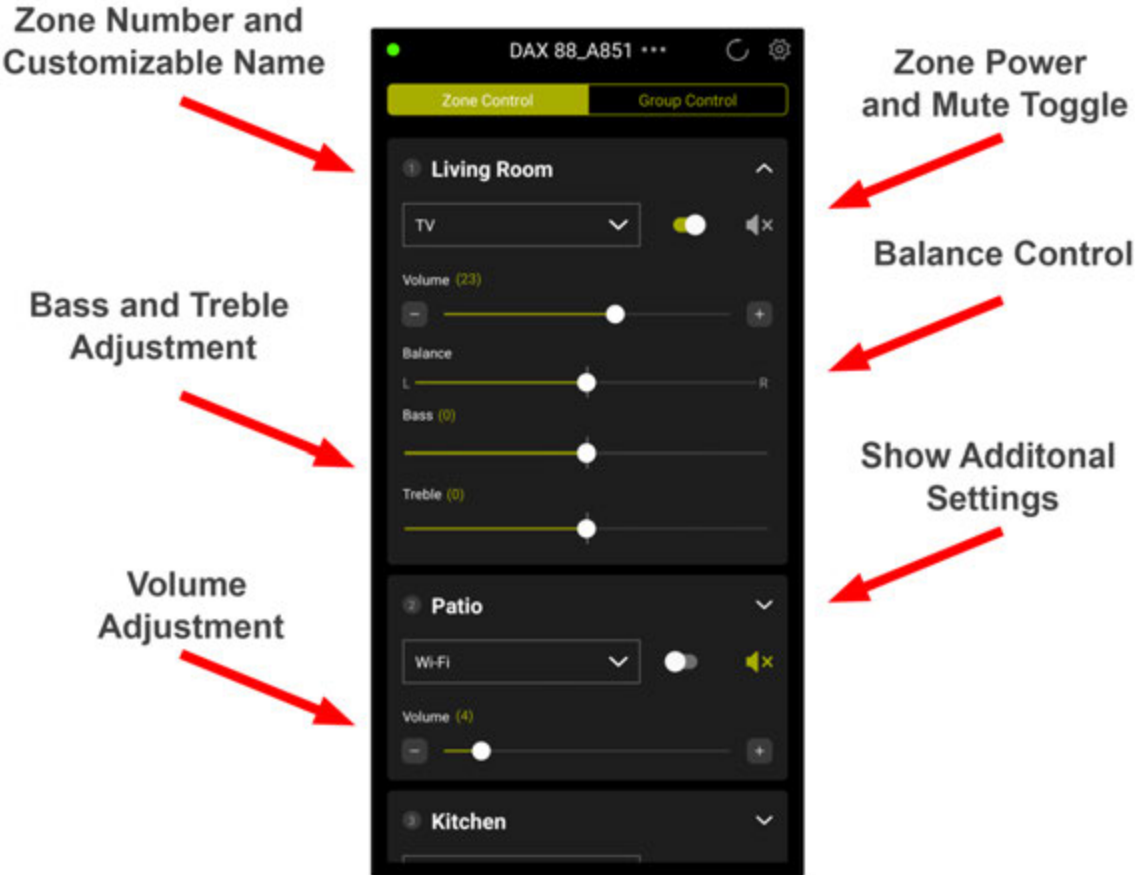



# Matrio™ - Mobile App Control

## Group Control

The Group Control menu allows a user to send commands to many zones at once. This mode works as if you had a remote control that was pointed at all of the zones you select, and selecting the commands from the top of the screen is like pressing a button on that remote. Create your 'group' by selecting zones from the list below the command section of your screen. Once you have picked your zones, any command you pick from the top will be sent to each of the zones in your group. Note that any changes made in the Zone Control menu or from another mobile device can 'desync' your group. This mode will not attempt to keep the zones you select in sync, if you want to 'resync' a setting of your group, you must press the appropriate command from the top of the screen.



# Matrio™ - Mobile App Control

## Setting up Your Device in the Dayton Audio Matrio™ App

The Dayton Audio Matrio™ app offers many customization options to make your DAX88 easy to use for any user. As can be seen below, there are three options for customization. All custom names get stored on the DAX88 itself and retrieved by the Matrio™ app, so for example, if an installer sets up the names in the app during installation, anyone who uses the app after installation will see these names automatically on any device. If multiple DAX88 devices are on the network, make sure to select the desired DAX88 unit by clicking the name at the top of the screen. The factory default name can be found on the back of the DAX88.

- 1) **Custom Device Naming** – This name will help you differentiate between units if you have multiple DAX88 units on your network. These names will then appear where you see “DAX88\_9215” in the screenshots below. This name will also be your AirPlay, DLNA, and Spotify Connect name.
- 2) **Custom Zone Naming** – You can give the zones on your DAX88 custom names, and these names will appear in the Zone Control and Group Control menus. For example, if you install a DAX88 in your home, you might have names of “Living Room”, “Dining Room”, “Kitchen”, “Patio”, etc.
- 3) **Custom Input Naming** – Customizing input names is useful if you have many inputs going into your DAX88 unit. Note that Input 8 is not customizable, as it will always be “Wi-Fi”.
  - a. Important: If you will be using input switching across multiple DAX88 devices using the group control menu, it is important to give any inputs you might have paralleled or common between devices the same exact custom name. More information can be found in the input installation section of this guide.

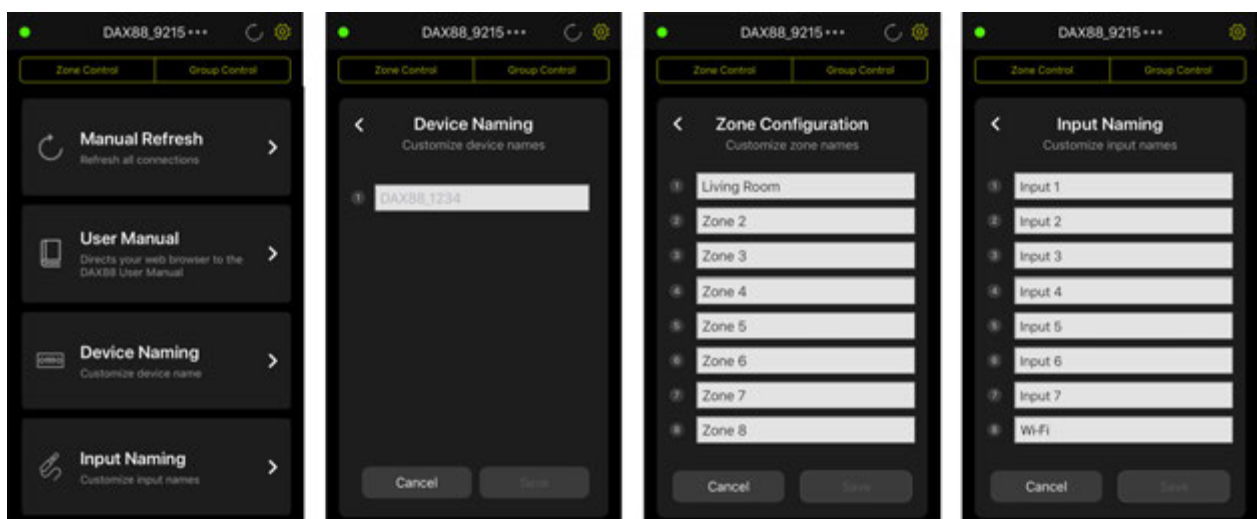

# Wi-Fi Streaming

---

Because the Dayton Audio DAX88 has Wi-Fi streaming technology built in, you can enjoy Wi-Fi streaming on any or all zones of your DAX88. There are many streaming options, but these options will vary depending on usage of an iOS or Android device as the streaming source. Make sure to set the appropriate zone of your DAX88 to Input 8 or 'Wi-Fi' before streaming. Your mobile device must be connected to the same wireless network as your DAX88 device before streaming. Details about adding additional streaming channels to your DAX88 can be found on the product's webpage.

## Apple AirPlay

Once connected to your network, the DAX88 will become available as an AirPlay streaming device on any Apple device connected to the same wireless network as the DAX88. As an example, look for the AirPlay logo as circled to the right in the Apple Music screenshot. AirPlay streaming is available on any modern Apple device, starting from iOS4.2 and OS X Mountain Lion. AirPlay is the best option for streaming to the DAX88 if you use Apple products. For more information about AirPlay, consult Apple's documentation about AirPlay by visiting their website.



## Spotify

Once configured on a network, your DAX88 should automatically show up as an available device in the Spotify Connect menu, regardless of which platform you are using. Spotify Connect requires a Spotify Premium account, and can be accessed by pressing the button circled to the right. This button is also available in the desktop application version of Spotify. You might need to restart your Spotify app or your mobile device for your DAX88 to show up in Spotify after installation or after a device name change.

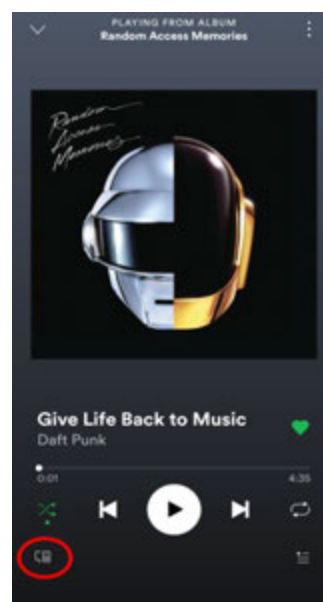

# Wi-Fi Streaming

## DLNA

The DAX88 is available as a DLNA device and is compatible with any DLNA certified player / server, for example BubbleUPnP.

## Dayton Audio Hi-Fly

On iOS devices, AirPlay can be used to stream almost any music service / app. On Android, there is no AirPlay, but the Dayton Audio Hi-Fly app enables more streaming services to be used. The list of the services that Hi-Fly supports can be seen in the screenshot below or within the app itself. Install the free Dayton Audio Hi-Fly application from the Google Play or iOS app store, and after launching the application you will see your DAX88 unit as an available device (as long as you are on the same network as your DAX88). Tap on your DAX88 and you will be given a list of steaming options as seen below.

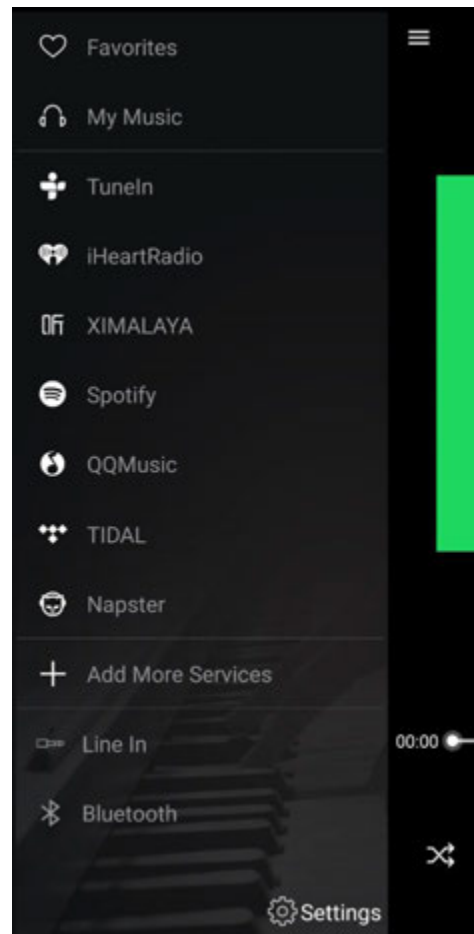
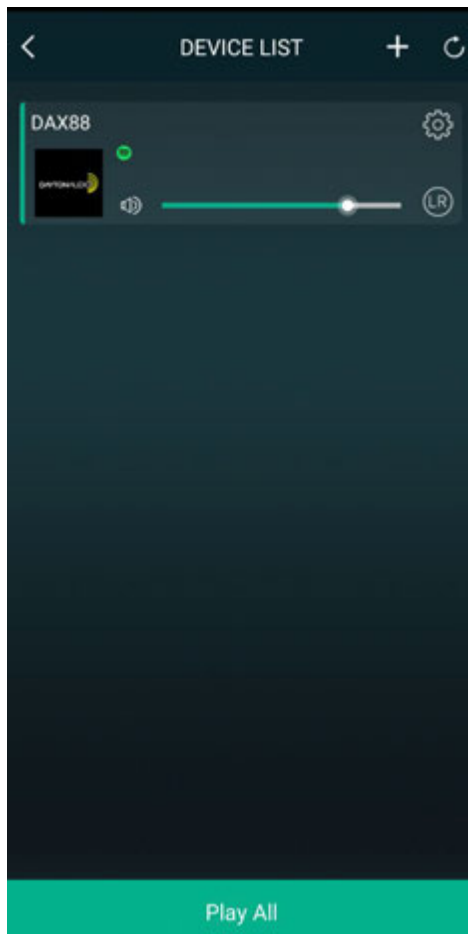

# Wi-Fi Streaming

---

## Notes

1) Those familiar with Dayton Audio Hi-Fly products will know that they can be grouped together in the Dayton Audio Hi-Fly app. While this is possible to do if you have multiple DAX88 devices, it is not recommended as it will temporarily disable control of the slave device(s) with the Matrio™ app while the devices are grouped (This is because it will disconnect the device from your house's / business' Wi-Fi, and connect it to the other DAX88's Wi-Fi in order to group it).

2) Wi-Fi streaming is reliant on a robust network with adequate levels of available bandwidth. If the DAX88's network connection is not strong enough, or if the wireless network is too congested, it can result in audio dropping in and out during streaming. Free up bandwidth on your network by pausing downloads, videos, or any other high bandwidth network usage. Consider upgrading your connection through your ISP and / or investing in higher quality networking equipment if this is a consistent problem.

3) With the wide range of inputs on the DAX88 and the ability to easily switch between them, external streaming devices such as smart assistants and Dayton Audio Hi-Fly devices can be easily added to the DAX88. See [www.daytonaudio.com/topic/DAX88manual](http://www.daytonaudio.com/topic/DAX88manual) for more information.

# Factory Reset

---

A factory reset of your DAX88 can be performed with the Dayton Audio Matrio™ app. Factory reset will erase any Wi-Fi settings, custom input names, custom zone names, and custom DAX88 unit names. If you have multiple DAX88 units on your network, only the currently selected DAX88 unit will be reset.

- 1) Open the Matrio™ app on your iOS or Android device
- 2) Open the Settings menu by pressing the gear icon in the top right corner of your screen.
- 3) If you have multiple DAX88 units on your network, make sure to select the correct unit that you are trying to factory reset by selecting the DAX88 name in the top of your screen and selecting the correct unit from the list. While in the settings menu, any changes made to settings or factory reset will **ONLY** affect one unit at a time.
- 4) Press the Factory Reset button, and then press reset when you are sure you want to reset your unit.
- 5) You will see a message that says your DAX88 has been reset. If you only had the single unit on your network, the app will close. If you have an additional unit on the network, the app will continue to work with the other unit.

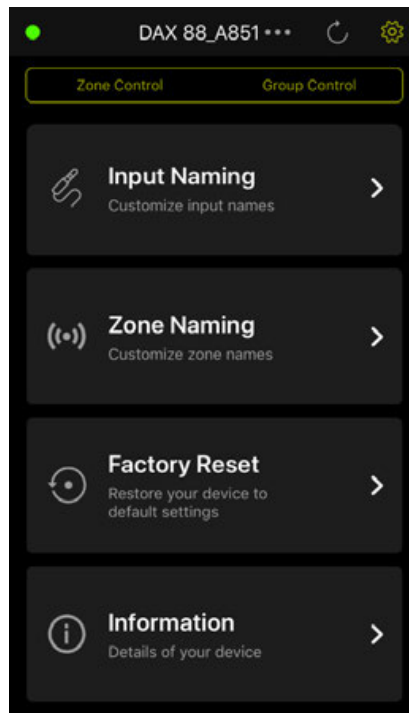

After a factory reset, it will take a few minutes for your device to work normally again. Please allow three minutes after pressing factory reset before resuming usage of your DAX88 or removing power. If your DAX88 is connected to the network via a wired ethernet connection, the Matrio™ app will eventually find the unit again and display it in

# Factory Reset

---

the app after Matrio™ is relaunched. If it does not, simply turn your DAX88 off and then back on again after waiting the three minutes.

If your device was connected to your network using a Wi-Fi connection instead of a wired connection (**NOT RECOMMENDED**), it will need to be reconfigured to the Wi-Fi network (instructions can be found within this document. Consider connecting your device with a hardwired ethernet connection for more stable performance.

# DAX88 Specifications

---

<b>RMS Power (All Channels Driven) @ 4~8 Ohms</b>	80 Watts / Channel
<b>RMS Power (All Channels Driven) @ 8 Ohms Bridge Mode</b>	200 Watts / Channel
<b>S/N Ratio</b>	>87 dB
<b>THD</b>	0.60%
<b>Frequency Response</b>	20 - 20,000 Hz
<b>Maximum Input Sensitivity</b>	800 mV
<b>Wi-Fi Frequency</b>	2400-2483.5 MHz
<b>Wi-Fi Power</b>	≤20 dBm (EIRP)
<b>Amplifier Protection</b>	Overload, Short Circuit, Thermal
<b>Trigger Systems</b>	DC 12V
<b>Input</b>	RCA, 3.5mm, Optical, Wi-Fi Audio Streaming (AirPlay, DLNA, Spotify Connect)
<b>Output Connectors</b>	Terminal Block, RCA
<b>Power Supply (Switchable)</b>	AC120/60Hz, 230V/50Hz
<b>Dimensions</b>	16.75" (W) x 4" (H incl. feet) x 14.25" (D)
<b>Weight</b>	17.3 lbs.
<b>Line Out Voltage</b>	1.5V
<b>Bass Control and Fc</b>	+/-12 dB @ 100 Hz (Shelf)
<b>Treble Control and Fc</b>	+/-12 dB @ 10kHz (Shelf)
<b>Power Consumption (Standby)</b>	23W
<b>Power Consumption (MAX)</b>	1390W
<b>Standby</b>	120 Minutes
<b>Warranty</b>	5 Years



# RS232 Serial Control

---

The DAX88 can be controlled by many home and commercial automation systems through its RS-232 serial port. The RS-232 command list, command structure, and transmission specifications are detailed below.

**Baud Rate: 9600**

**Data Bits: 8**

**Stop Bits: 1**

**Parity: None**

**Flow Control: None**

**'CR': Carriage Return (0x0D) is required**

**Control command structure <xxPPuu'CR'**

**xx: Zone number**

01: Zone1

02: Zone2

03: Zone3

04: Zone4

05: Zone5

06: Zone6

07: Zone7

08: Zone8

**uu:** indicates a value that the command uses, such as 0-38 for volume control

**PP:** indicates one of the following control action codes

**PR:Power control**

PR00:Power off

PR01:Power on

**MU:Mute control**

MU00:Mute off

MU01:Mute on

# RS232 Serial Control

---

## **V0:Volume control**

V0(00-38):Volume control

## **TR:Treble control**

TR(00-24): Ranges from -12 to +12

Example: <01TR00 sets zone 1 treble to -12

<03TR12 sets zone 3 treble to 0

<05TR24 sets zone 5 treble to +12

## **BS:Bass control**

BS(00-24):Bass control. Ranges from -12 to +12

Example: <01BS00 sets zone 1 bass to -12

<03BS12 sets zone 3 bass to 0

<05BS24 sets zone 5 bass to +12

## **BL:Balance control**

BL(00-20):Balance control.

Example: <01BL00 sets zone 1 balance to 100% left

<03BS10 sets zone 3 balance to normal

<05BS20 sets zone 5 balance to 100% right

## **CH:Source control**

CH(01-08):Source control

### **Examples of Various Commands :**

Set Zone 1 to Power Off <01PR00

Set Zone 1 to Volume 23 <01V023

Set Zone 1 to Power On <01PR01

Set Zone 6 to Source 4 <06CH04

# RS232 Serial Control

---

**Ask Status command structure** ?xx'CR'

xx: Indicates the control object code

01 : Zone1

02 : Zone2

03 : Zone3

04 : Zone4

05 : Zone5

06 : Zone6

07 : Zone7

08 : Zone8

.....

**Reply command:** >xxaabbccddeeffgghhijj'CR'

aa:PA Control Status

bb:Power Control Status

cc:Mute Control Status

dd:DT Control Status

ee:Volume Control Status

ff:Treble Control Status

gg:Bass Control Status

hh:Balance Control Status

ii:Source Control Status

jj:Keypad Connection status (00:Not connected, 01:Connected)

# Troubleshooting

---

## **The Matrio™ app will not connect to my DAX88 even though I have set it up on my network.**

Carefully re-read the network connection section of this guide. If that does not solve the problem, try the following solutions.

- 1) Your DAX88 is not switched on or connected to power.
- 2) Your Wi-Fi network is not working properly or your DAX88 is not configured to your network.
- 3) Your mobile device is not connected to the same network as your DAX88.
  - a. Your mobile device is connected to a different Wi-Fi network, or a different Wi-Fi zone or hot spot that is not configured to be on the same network as your DAX88.
  - b. Your mobile device has Wi-Fi turned off.
  - c. You are out of range of your Wi-Fi network.
- 4) If you have connected your DAX88 to your network with Wi-Fi, try instead to connect it to your network with a hardwired ethernet connection. If you have setup the DAX88 with Wi-Fi, factory reset the device after re-entering the Matrio™ app. Connecting your DAX88 with both Wi-Fi and ethernet can cause network stability issues in the Matrio™ app. After the factory reset, your ethernet connection will continue to work and the Wi-Fi settings will be erased.
- 5) Try using the Matrio™ app on a different mobile device to see if your current mobile device is causing the issue.
- 6) Reset the DAX88 by turning the device off and then on again after a few moments.

## **The Matrio™ app frequently says it cannot find my DAX88 unit on my network, but sometimes it connects and works fine.**

This could be a symptom of a few different problems with your setup.

- 1) Your DAX88 is not connected to your network with an ethernet cable, but instead connected over Wi-Fi.
  - a. Hard wiring the device with ethernet to your network will usually resolve stability issues. Before or after making your ethernet connection, factory reset your device to remove all Wi-Fi connection settings. This is necessary because being connecting your DAX88 with both ethernet and Wi-Fi can cause stability issues.
- 2) You are trying to access the Matrio™ app in a location where your Wi-Fi signal strength is poor.

# Troubleshooting

---

- 3) If you have multiple DAX88 units, make sure they are **ALL** hardwired to your network.
- 4) Your mobile device has issues with its Wi-Fi antenna. You can test this by trying a different mobile device with the Matrio™ app in the same location.
- 5) Your mobile device is switching Wi-Fi networks as you move around locations of your home or business. This will not happen with a properly configured network, but it is possible depending on the Wi-Fi configuration.
- 6) You have your DAX88 connected to the network with both ethernet and Wi-Fi

## **I am not getting sound out of my speakers.**

There are many reasons this could be happening. The best way to fix the problem will be re-reading this guide's sections about setup and carefully following the instructions. An additional list of things to check for follows.

- 1) Make sure you have made proper connection to your speakers, and that you have wired the green phoenix connectors correctly.
- 2) Check that the zone you are trying to use is on by either using the Matrio™ app or a corresponding keypad.
- 3) Make sure that you have routed your desired input to the correct zone using the Matrio™ app or corresponding keypad
  - a. If you are trying to use Wi-Fi streaming, make sure you are set to input **8** on the current zone.
- 4) Check that your input source is working correctly.
- 5) If streaming with Wi-Fi, make sure that your Wi-Fi network is working well. If a network is too congested with other traffic, it might have problems streaming music.

## **My DAX88's Wi-Fi is password protected, but it is not configured to my network.**

The easiest way to solve this issue is to move the DAX88 to a location where it can be directly connected to your network with an ethernet cable. Once this connection is made, the DAX88 unit can be factory reset through the Matrio™ app. This will remove the Wi-Fi password.

# Troubleshooting

---

## **Spotify does not display the DAX88 as an available streaming device.**

1) Once the DAX88 is configured to a network, Spotify should display it as an available streaming device, no matter which platform you are using it on (iOS, Android, Windows, Mac). If Spotify does not recognize the DAX88 and you are confident you are on the same network as your DAX88, please install the Dayton Audio Hi-Fly app from the Android or iOS app store. Once installed, select your DAX88 device and then select Spotify, and then press “open in Spotify”. If you do not see your DAX88 device in the Hi-Fly app, this means your mobile device is not on the same network as your DAX88, or you have not properly configured your DAX88 to your network.

2) If the above step does not work, try giving your DAX88 a different custom name (one you have never used before on any other Wi-Fi device) through the Settings menu, and make sure that you do not have two DAX88 units with the same exact name. You might need to close and re-open your Spotify app or even restart your mobile device for this change to work.

## **When streaming music over Wi-Fi, the sound from the speakers goes in and out / on and off.**

Streaming dropout issues are caused by your wireless network in most cases, and this is much more likely to occur if you have setup your DAX88 to connect to your network over Wi-Fi instead of with an ethernet cable. Otherwise, make sure that the device you are streaming from (a phone, tablet) has a strong Wi-Fi signal. If the sound drops out as you move around your house or business, there are likely spots where your signal strength is poor, or someone or something else on your network is using all of the network’s bandwidth, for example by streaming high resolution video or by downloading a game.

If this is a consistent issue, contact your internet provider for options to improve your network.

# Troubleshooting

---

## **My DAX88 is not showing as an available AirPlay device.**

- 1) Apple AirPlay is only supported on Apple devices; AirPlay will not work on an Android or Windows device.
- 2) Your iPhone, iPad, or Mac is not connected to the same network as your DAX88, or Wi-Fi on your Apple device needs turned on.
- 3) Your DAX88 is not on or is not configured to your network.
- 4) If you are sure that you are on the correct network and everything should be working properly, try giving your DAX88 a new custom name with the Matrio™ app (this will change the AirPlay name) and restart your Apple device. This new custom name should be different from any other Wi-Fi device on your network.

## **I grouped my multiple DAX88 units together in the Dayton Audio Hi-Fly mobile app, but now I can only see one of my DAX88 units in Matrio™.**

Grouping DAX88 devices in this way will prevent all devices that are not the master device from connecting to the Matrio™ app. This is because grouping your devices together connects their Wi-Fi together, and disconnects non-master devices from your wireless network. To resolve this issue, simply ungroup the devices. Look to the “Installation – Audio Sources” section of this guide for other ways of sharing inputs between your DAX88 devices.

## **All of my zones turned off after two hours of not using the device.**

The DAX88 will go into Standby mode after two hours in the absence audio input as a power saving feature. All of your zones will be turned off after this time.

## **I need to make changes to the settings of my DAX88, but I do not have a wireless network.**

It is possible to control your DAX88 unit with the Matrio™ app without a wireless network, which can be useful if internet connection is lost or not enabled yet. Simply download the Dayton Audio Matrio™ app from the app store on your iOS or Android device, and then connect to your DAX88's Wi-Fi network using the settings menu of your mobile device. You will not be able to access the internet until you disconnect from this network, but it will allow you to temporarily control your DAX88 by using the Matrio™ app.

The DAX88 can also be controlled without a network connection at any time by using the DAX88KP Keypads.

# Troubleshooting

---

## **My keypads do not work.**

Your ethernet cables might have been terminated incorrectly. Fully reread the keypad installation section of this manual (Installation – Keypads).

- 1) If you have terminated your own cables, make sure that they have been crimped in the 'B' configuration.
- 2) DAX66 keypads are not compatible with the DAX88.
- 3) Make sure that there are no shorts. Verify each speaker's location and test each cable with a network cable tester with remote unit. This saves you time identifying each speakers location and making sure all wiring is correct when you set up each zone.
- 4) Make sure that you have made connection to the DAX88KP keypad on one end, and the DAX88HUB Keypad Hub on the other end. Make sure that your DAX88HUB is connected to your DAX88 in the KEYPAD port, NOT the network port.
- 5) Check that your DAX88 is connected to power and switched on.

## **My keypads are not controlling the correct zones.**

Make sure that you have configured the dip switches on the back of each keypad according to this manual (Section "Installation – Keypads"). Even though the connections on the keypad hub are labeled 1 - 8, these dip switches must still be configured for proper control with the keypads.

## **I live in a country that uses 115V Power, but I accidently switched the device on while the voltage switch was set to 230V mode.**

Your DAX88 will protect itself. It will appear to be working properly in this scenario, but you will not get any sound from the amplifier. To fix this, simply turn off the DAX88, disconnect power from the DAX88, and change the DAX88 to 115V voltage mode. After restoring power and switching the DAX88 back on, it will work normally.

## **I live in a country that uses 230V Power, but I accidently switched the device on while the voltage switch was set to 115V mode.**

Your DAX88 has been damaged. Disconnect power from the device and contact customer support.



# Troubleshooting

---

## **Volume is not loud enough or as loud as I expect.**

- 1) Check if your source volume can go higher, either on a source device or in a streaming app.
- 2) Check that you are adjusting the correct zone's volume
- 3) Your speakers could be wired out of phase. More information can be found in the "Installation – Speakers" section.
- 4) If you tried to wire two 8 ohm speakers in parallel to create a 4 ohm load (do not do this in bridged mode, as the minimum is an 8 ohm load for bridged mode), you might have instead accidentally wired them in series and created a 16 ohm load.

## **The sound from my speakers is distorted.**

- 1) The speakers themselves are damaged or their power handling is too low to achieve the volume levels you desire.
- 2) The output voltage from your input device is too high. The DAX88 can only handle up to 2V from an analog input before it will start to distort the audio. Otherwise, the distortion could be coming from your input device.
- 3) If you are using an optical connection, check the user manual of your source device to set the audio mode to "PCM". Auto Detect should work as well, but set to PCM if it is not working properly.

## **Noise / Hum**

- 1) Cables routed near AC line cables and/or transformers can have noise induced into them.
- 2) Speaker wires run next to AC wires for long distances can have noise induced into them.
- 3) Electronically noisy devices (motors, etc.) are operating on same circuit or nearby.
- 4) Poor equipment ground. Make sure that all AC grounds are connected.
- 5) Make sure that all components in the audio chain are connected to the same ground.

**5-Year Limited Warranty**  
See [daytonaudio.com](http://daytonaudio.com) for details



**daytonaudio.com**  
tel + 937.743.8248  
[info@daytonaudio.com](mailto:info@daytonaudio.com)

705 Pleasant Valley Dr.  
Springboro, OH 45066  
USA

