

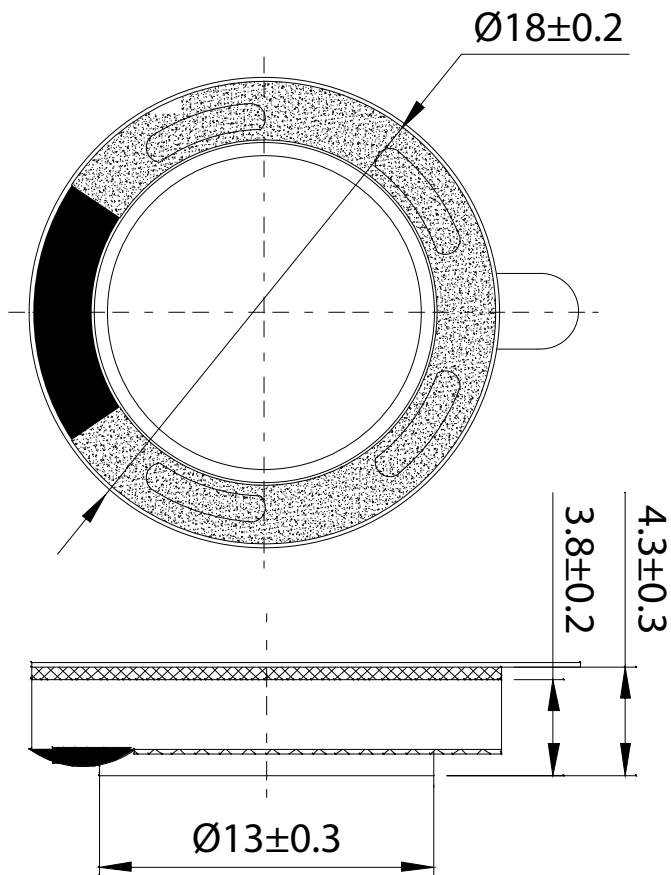

3/4" Round Mini Speaker Buzzer 8 Ohm

CE18Z-8



PARAMETERS

Impedance	8 ohms
Re	N/A
Le	N/A
Fs	750 Hz
Qms	N/A
Qes	N/A
Qts	N/A
Mms	N/A
Cms	N/A
Sd	N/A
Vd	N/A
BL	N/A
Vas	N/A
Xmax	N/A
VC Diameter	N/A
SPL	N/A
RMS Power Handling (AES 426B)	0.8 watts
Usable Frequency Range (Hz)	750 - 5,000 Hz

IMPEDANCE/PHASE

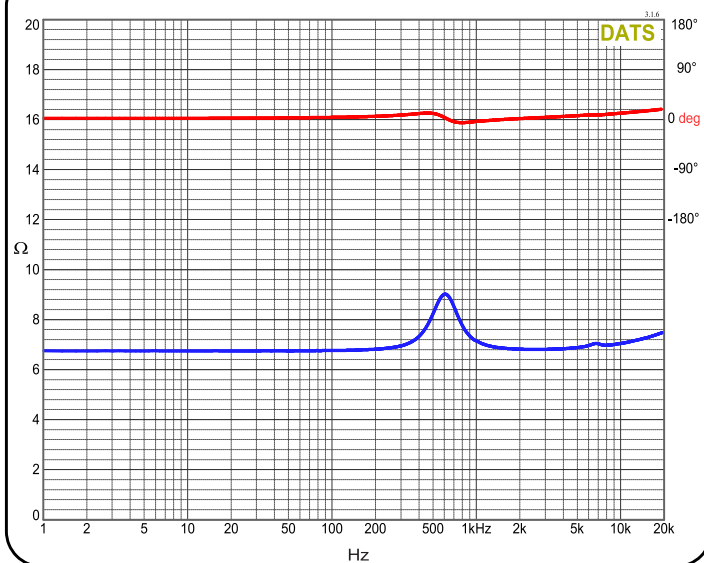

FEATURES

- High economic value
- High-quality audio solutions without breaking the bank, ideal for budget-conscious projects
- Suitable for commercial use, DIY projects, art exhibits, and more

FREQUENCY RESPONSE

